

AC Servo System



Driving and Connecting Globally





TECO

AC Servo System Features

Complete Model

TECO JSDA & JSDE servo pack when integrated with JSMA Servo Motor 50W ~ 15KW, and combined with a 2500 / 8192 ppr incremental encoder will provide excellent performance for a wide range of applications.

Multi-Function

Torque, Speed, Position, Point to Point setting and dual control mode, which enables optimal control by integration with other control systems.

Main Circuit/ Control Circuit Power Separation

Effective protective function, simple to check available for JSDA.

Built-in Brake Unit

To meet the requirement of high inertia load changes
 JSDA: Built-in Braking transistor and Braking resistor
 JSDE: Built-in Braking transistor

Simple Gain tuning

Built-in 10 levels of system rigidity setting and ON-Line / OFF-Line auto gain tuning

Notch Filter

Effective suppression of mechanical resonance to provide a stable control system

Flexible Gain Control Switching

Speed loop PI(Proportional-Integral) control and P(Proportional) control switching can suppress overshoot and undershoot while motor speeds up or down.

Built-in 16 Sets programmable position settings, which enable point to point position control

Smoothing Effect

In position/ speed mode, the adjustment of time parameter modifies the speed/ position curve, provides smooth operation, therefore extends the life expectancy of the mechanical system.

User friendly interface. Displays Status indication and Diagnostics

Multi-sets of programmable I/O ports for multi-function.

Complete protective function and multiple alarms for abnormal system behavior

PC operating client software on TECO SERVO

With Chinese traditional font/Chinese simplified font/English version on TECO SERVO for parameter read/write, gain adjustment, status indication and digital scope simulating for monitoring internal signals through RS-232 interface.

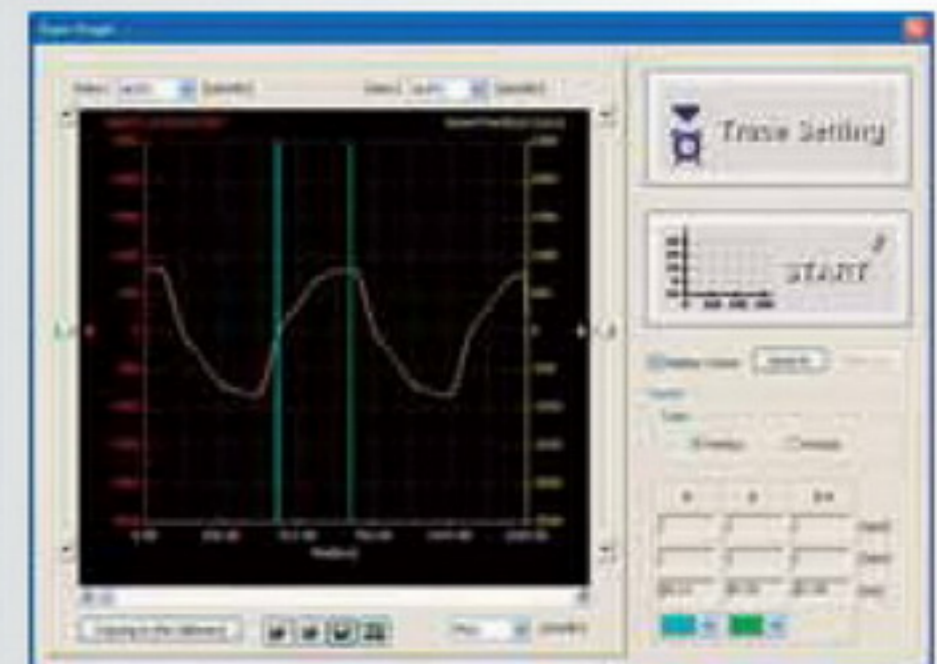
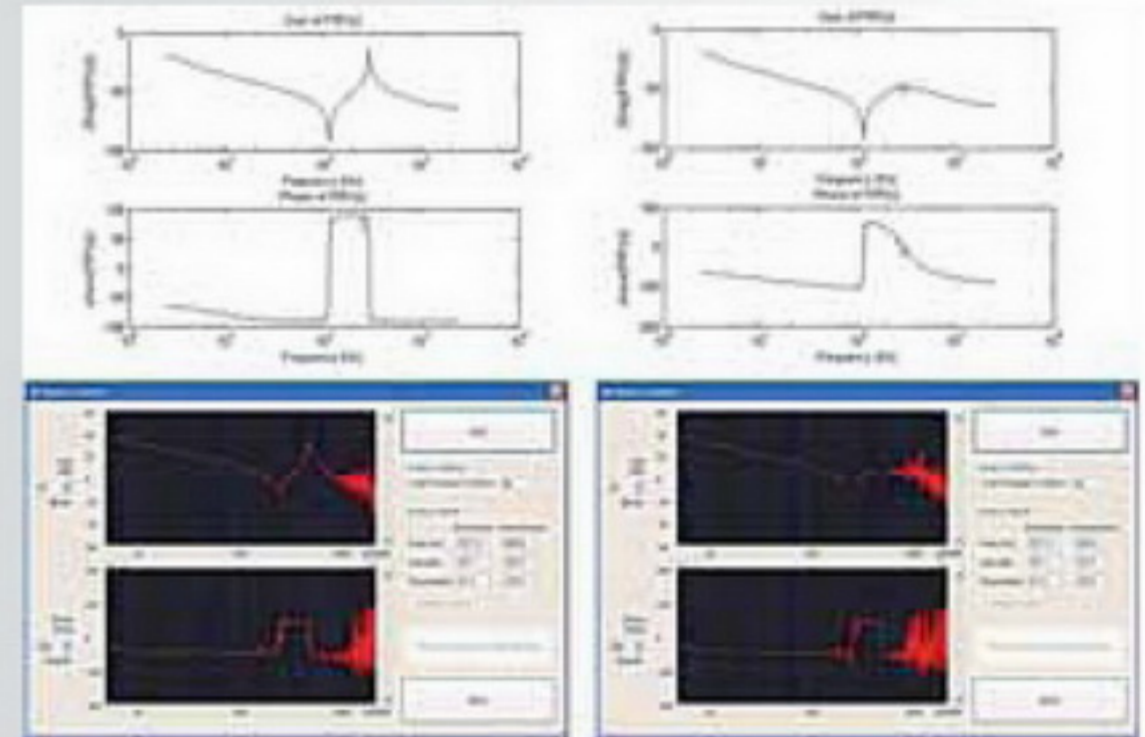

System Examples

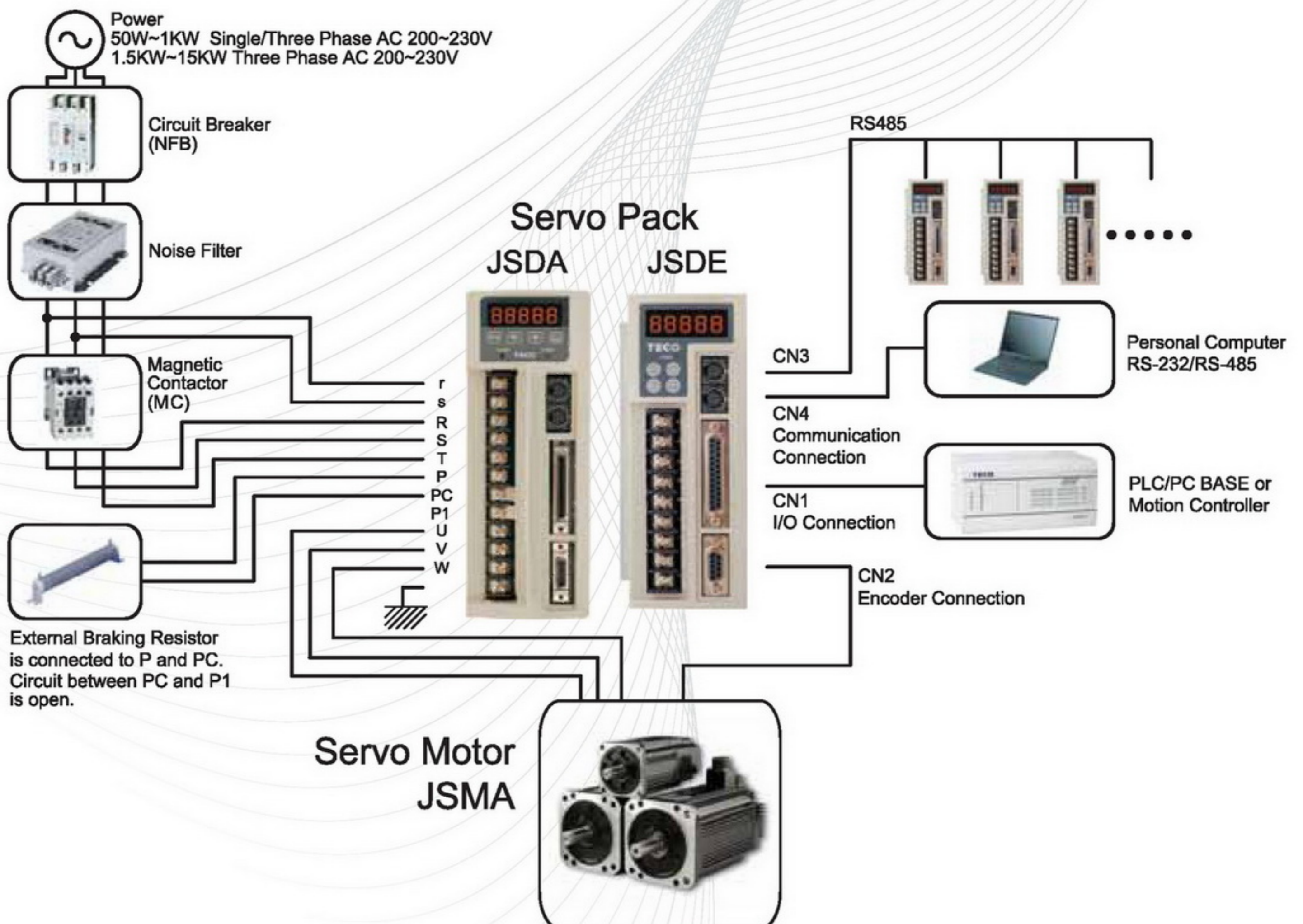
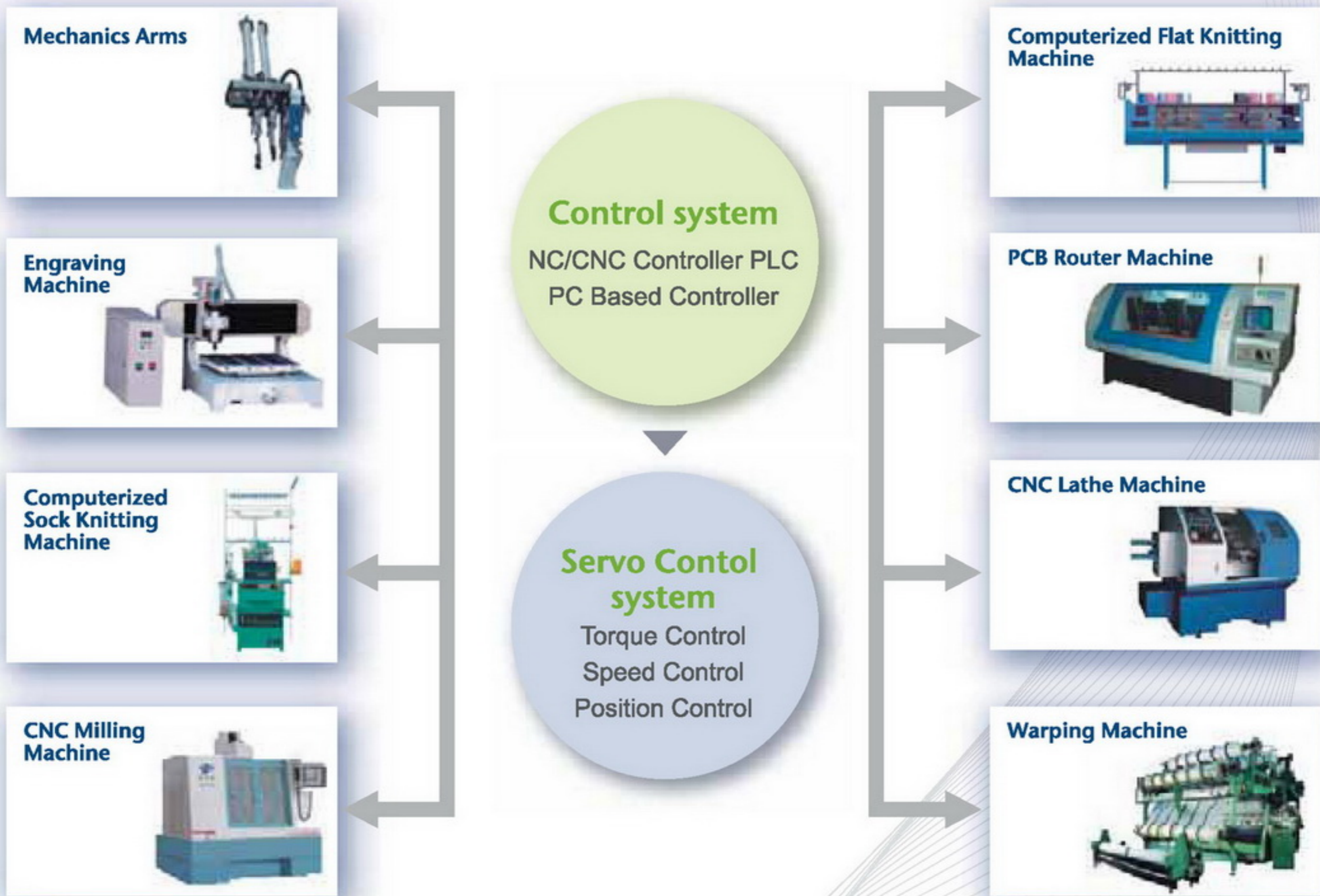



Servo Pack Model Designation

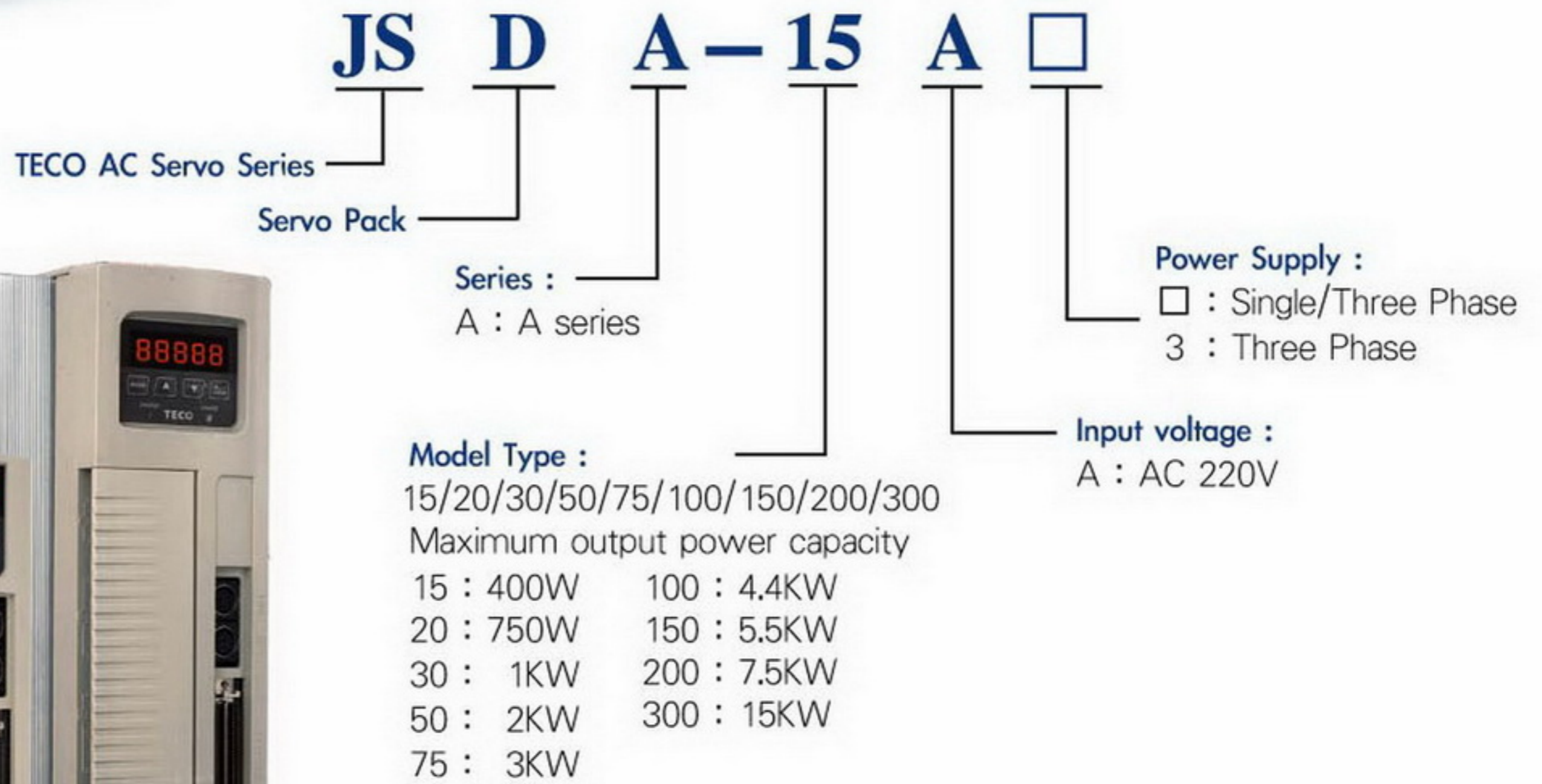

JSDA Servo Pack Dimension (mm)

JSDA-15A/20A/30A

	W
JSDA-15A/20A	69
JSDA-30A	80

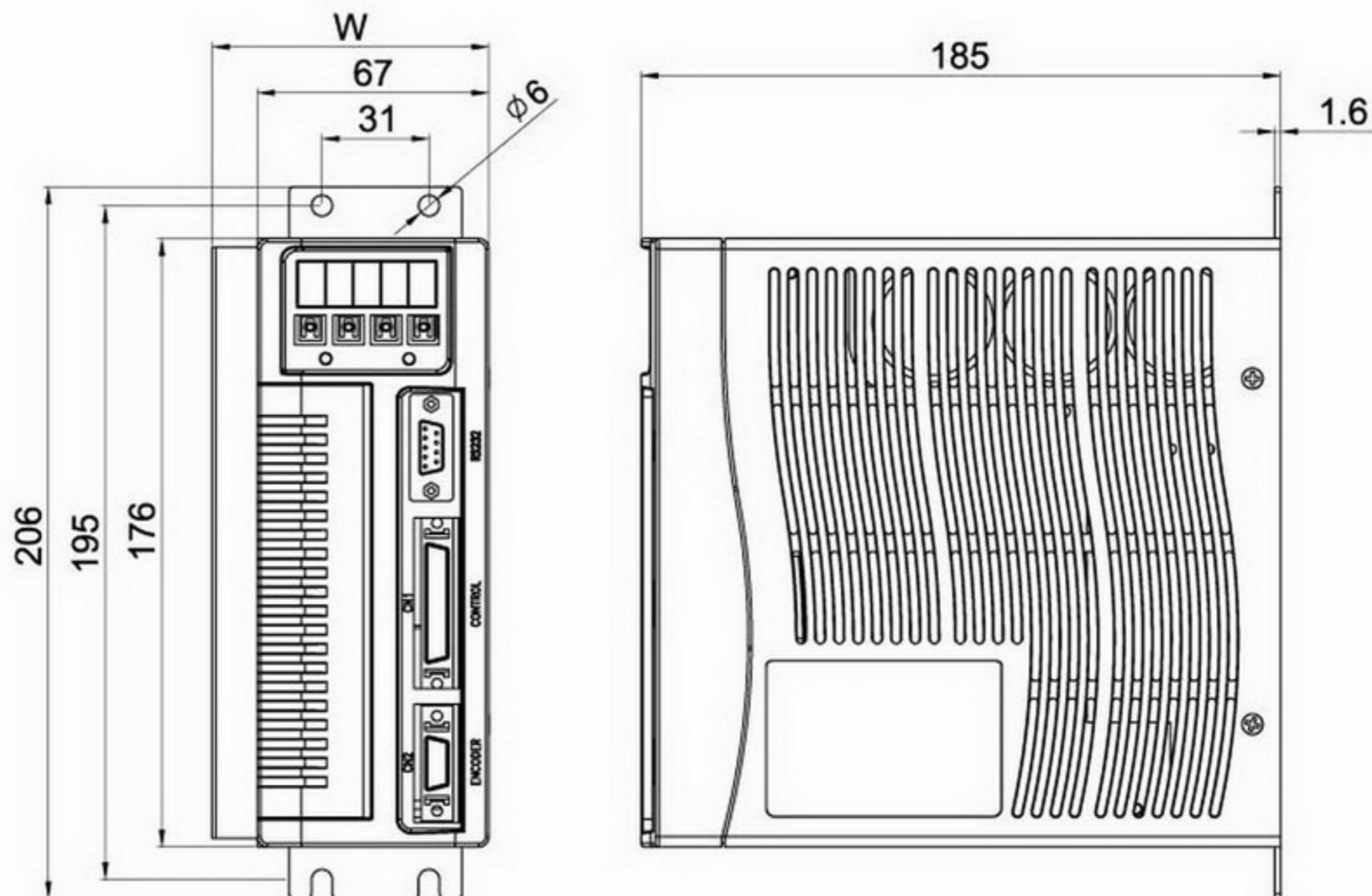

JSDA-50A3/75A3/100A3

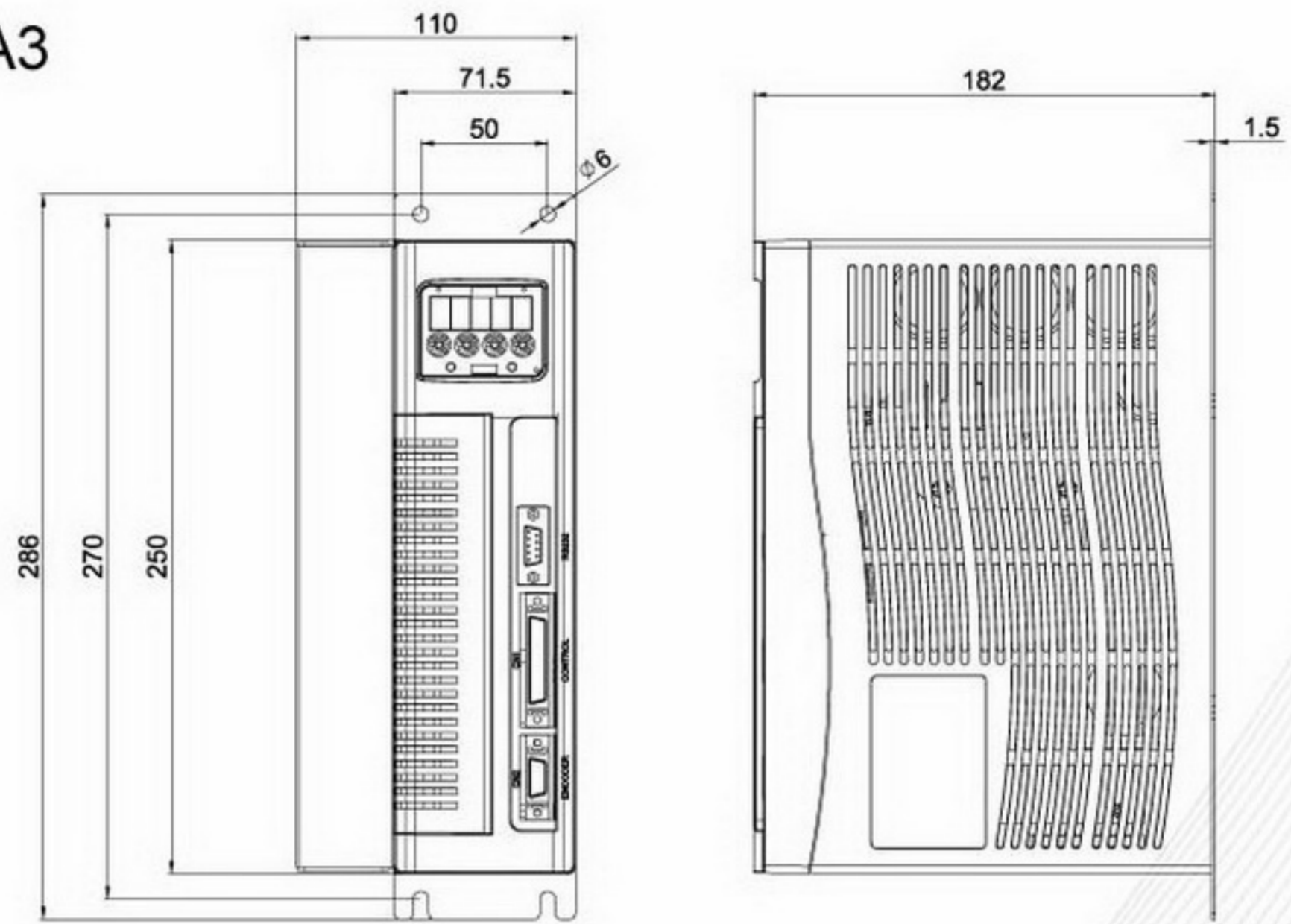

JSDA-150A3

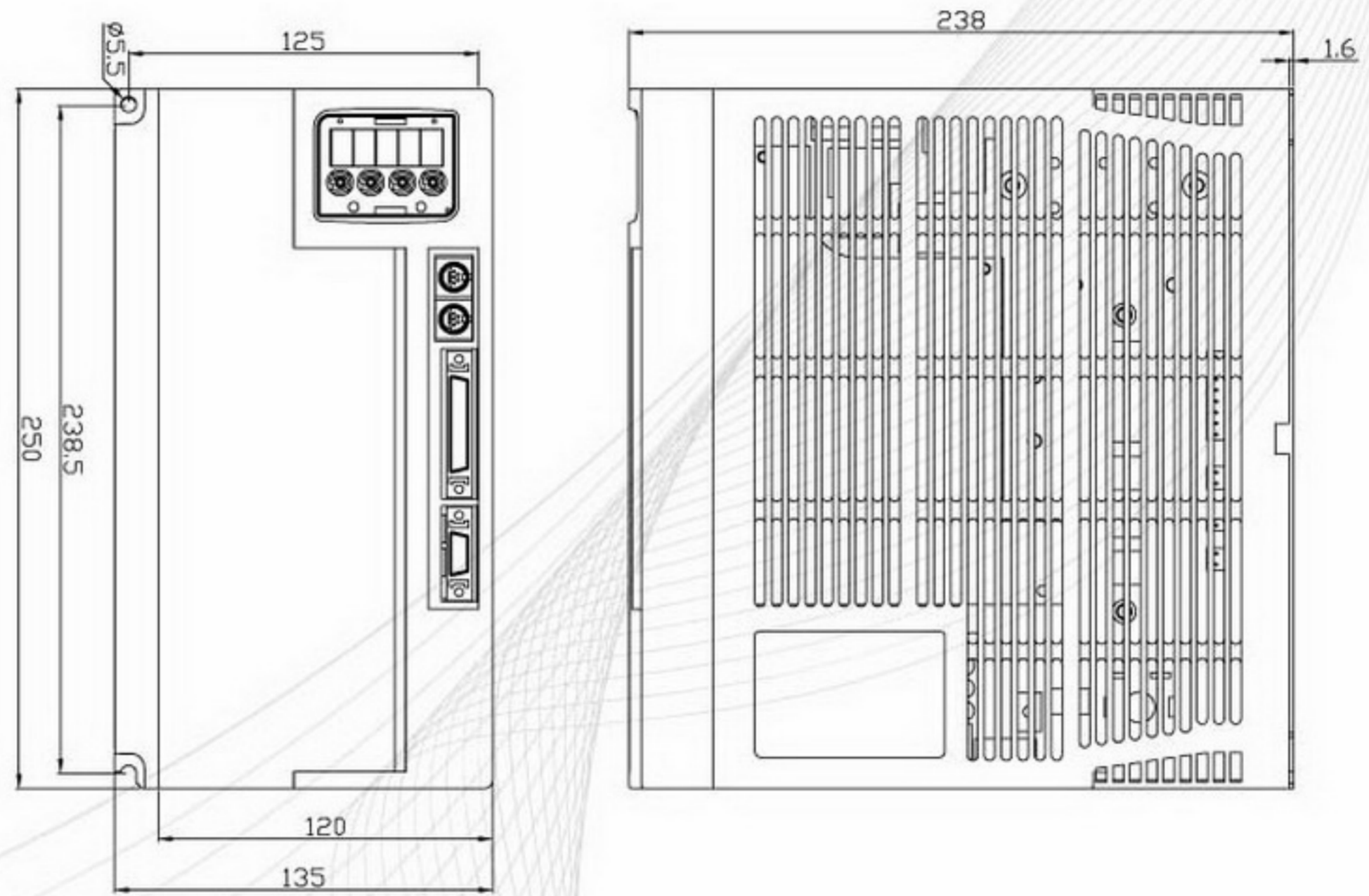

JSDA-200A3/300A3

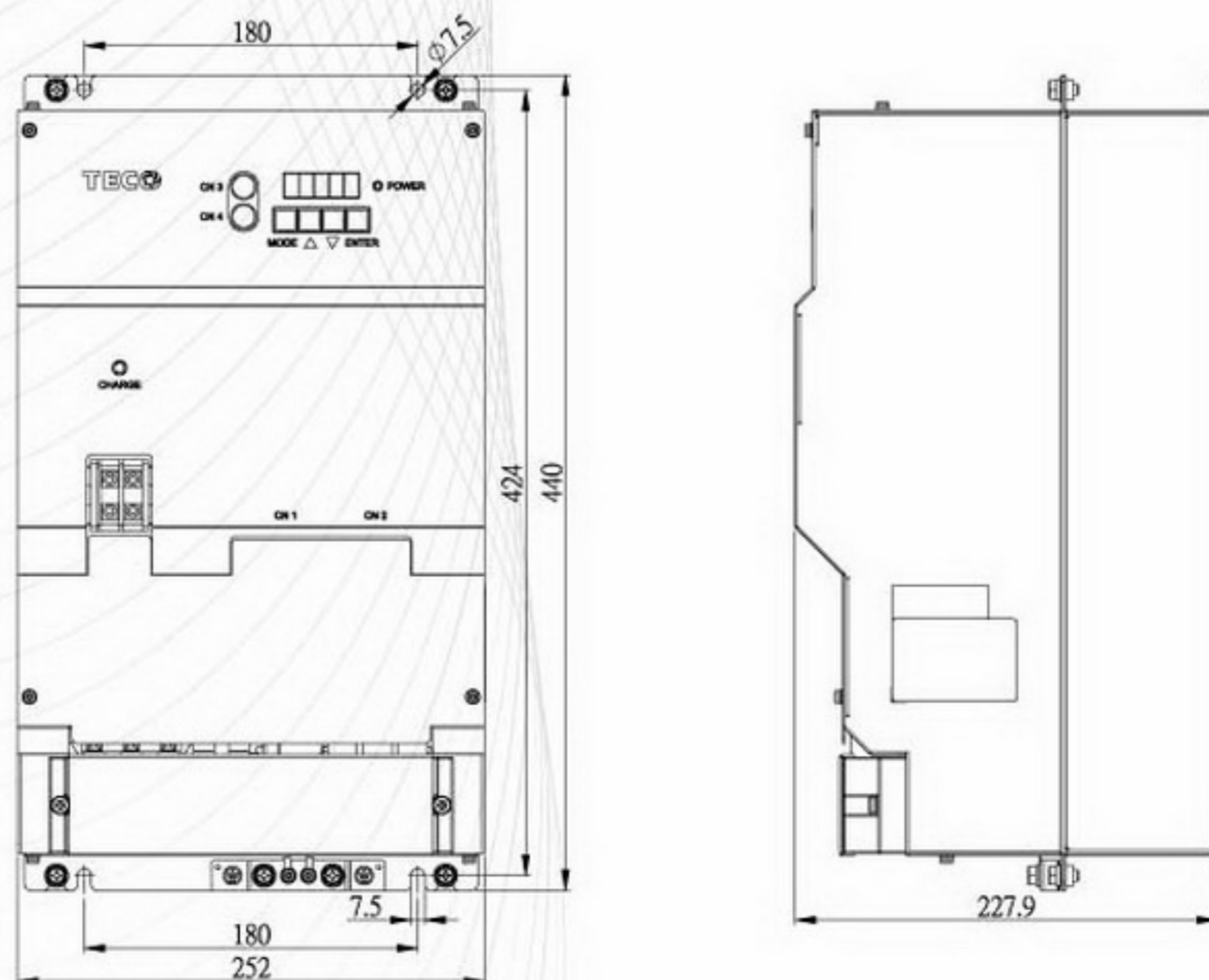



JSDA Specifications

Servo Pack Model JSDA-□□□□		15A	20A	30A	50A3	75A3	100A3	150A3	200A3	300A3	
Applicable Servo Motors JSMA-□□□□		SC01	SC04	SC08	MA15	MB30	MH44	MH55	MH75	MH110	
		SC04*	SC08*	MA10	MB15	MC30	HH30	HH44	HH55	MH150	
		LC03	LC08	MB10	MC15	MH30	—	—	—	—	
		—	MA05	MC10	MB20	—	—	—	—	—	
		—	MH05	MH10	MC20	—	—	—	—	—	
Basic Specifications	Max. Applicable Servo Motor Capacity [KW]	0.4	0.8	1.0	2.0	3.0	4.4	5.5	7.5	15.0	
	Continuous Output Current [A rms]	3.5	4.4	5.16	9.5	14.0	23.0	33.2	42.1	78.0	
	Max. Output Current [A rms]	10.5	13.2	15.5	28.5	42.0	59.8	86.3	109.5	170.0	
	Input Power Supply	Main Circuit R、S、T	Single-phase / Three-phase 170 ~ 253Vac			Three-phase 170 ~ 253Vac					
		Control Circuit r、s	50 / 60Hz ±5%								
	Cooling System		Natural Air Circulation			Fan Cooling					
	Control Method		Three-phase full-wave rectification IGBT-PWM (sine-wave driven)								
	Feedback [Encoder Resolution]		Incremental Encoder : 2000ppr / 2500ppr / 8192ppr								
Internal Functions	LED Display	Charge / Power lamps ; Five 7-segment LEDs ; Four function keys									
	Control Mode	Position (External or Internal) 、 Speed 、 Torque and Dual control mode (P/S 、 S/T 、 P/T)									
	Regenerative Discharge	Built-in braking transistor and resistor (External braking resistor connectable)								Built-in braking transistor (External braking resistor connectable)	
	Dynamic Brake	Active after Power-off 、 Servo-off 、 Limit switch and Protective function									
	Protective Functions	Under voltage 、 Over voltage 、 Over load 、 Over current 、 Encoder error 、 Abnormal DI/DO programming 、 Memory abnormal 、 Emergency stop 、 Pulse deviation value 、 Over speed 、 CPU abnormal 、 Limit switch error 、 Over heat									
	Communication Interface	RS-232 / RS-485 (Modbus protocol)									
Position Control Mode	Command Source		External pulse train / Internal parameters (16 programmable position settings)								
	Input Signals	Type	Positive/Negative edge triggered : Sign + Pulse train 、 CCW + CW pulse train 、 90° phase difference 2-phase pulse (phase A + phase B)								
		Form	Line Driver (+5V level) 、 Open Collector (+5 ~ +24V level)								
		Frequency	Maximum 500 / 200 kpps (line driver/open collector)								
	Electronic Gear Ratio	1/200 ≤ A/B ≤ 200 (A=1 ~ 50000 ; B=1 ~ 50000)									
	Position Time Constant	Smoothing : 0 ~ 10sec									
	Final Position Tolerance	0 ~ 50000 Pulse									
	Feed Forward Compensation	0 ~ 100 %									
Homing Function	Set by parameters										
Speed Control Mode	Command Source		External analog signal / Internal parameters (3 speeds set-up)								
	Analog Input Signals	Voltage Range	0 ~ ±10Vdc / 0 ~ 4500rpm (set by parameters)								
		Impedance	10KΩ								
	Speed Control Range	1 : 5000 (Internal) / 1 : 2000 (External)									
	Speed Fluctuation Rate	0.03% or less at load fluctuation 0 ~ 100% (at rated speed)									
		0.2% or less at power fluctuation ±10% (at rated speed)									
		0.5% or less at ambient temperature fluctuation 0 ~ 50 °C (at rated speed)									
	Accel./Decel. Time Constant	Linear : 0 ~ 50sec ; S curve : 0 ~ 5sec ; Smoothing : 0 ~ 10sec									
Frequency Characteristics	Maximum 400Hz (at J _L =J _M)										
Torque Limit Operation	External analog signal / Internal parameters										
Zero Speed / Speed Reach Range	0 ~ 4500rpm (set by parameters)										
Torque Control Mode	Command Source		External analog signal								
	Analog Input Signals	Voltage Range	0 ~ ±10Vdc / 0 ~ ±300%								
		Impedance	10KΩ								
	Accel./Decel. Time Constant	Linear : 0 ~ 50sec									
	Speed Limit Operation	External analog signal / Internal parameters									
Torque Reach Range	0 ~ 300% (set by parameters)										
Input/Output Signals	Position Output	Form	Phase A 、 B 、 Z Line Driver / Phase Z Open Collector								
		Frequency Dividing Ratio	1 ~ 8192 (Rotation resolution) any arbitray value								
	Digital Input [NPN/PNP]	13 ports Signal allocation can be modified.	Servo on 、 Alarm reset 、 P/PI switching 、 Forward/Reverse limit switch 、 External torque limit 、 Pulse deviation clear 、 Servo lock 、 Emergency stop 、 Speed command selection 、 Control mode switching 、 Pulse command inhibit 、 Gain switching 、 Electronic gear ratio setting 、 Internal pulse command trigger 、 Internal pulse command pause 、 Homing mode positioning 、 External reference signal 、 Internal position command switching 、 Speed/Torque command reverse 、 Torque mode forward/reverse start								
	Digital Output [Photocoupler]	4 ports Fixed Output	Servo alarm code 、 Torque limit 、 Limit switch 、 Base block								
		4 ports Signal allocation can be modified.	Servo ready 、 Servo alarm 、 Zero speed 、 Brake interlock 、 Speed reach 、 Positioning completed 、 Homing completed 、 Torque reach								
Analog Monitor Output	2 ports Signal allocation can be modified.	Speed feedback 、 Torque / Speed / Position command 、 Pulse deviation value 、 electrical angel 、 Main circuit voltage (Vdc Bus)									
Environment	Installation Site		Indoor location (avoiding direct sunshine) No corrosive liquid and gas (avoiding oil mist 、 flammable gas 、 dust)								
	Altitude		Altitude 1000M or lower above sea level								
	Temperature		Operating temperature : 0 ~ 50°C ; Storage temperature : -20 ~ +85°C								
	Humidity		90%RH or less (with no condensation)								
	Vibration		10 ~ 57Hz : 20m/s ² ; 57 ~ 150Hz : 2G								

* Transient torque is 2.4 times rated torque for this combination.



Servo Pack Model Designation

JS D E - 15 A □

TECO AC Servo Series

Servo Pack

Series :
E : E series

Model Type :
10/15/20/30/50
Maximum output power capacity
10 : 100W
15 : 400W
20 : 750W
30 : 1KW
50 : 2KW

Power Supply :

□ : Single/Three Phase
3 : Three Phase

Input voltage :
A : AC 220V



JSDE Servo Pack Dimension (mm)

JSDE-10A/15A/20A/30A/50A3

	H	H1	W
JSDE-10A/15A	160	152	67
JSDE-20A/30A	160	152	80
JSDE-50A3	206	195	80

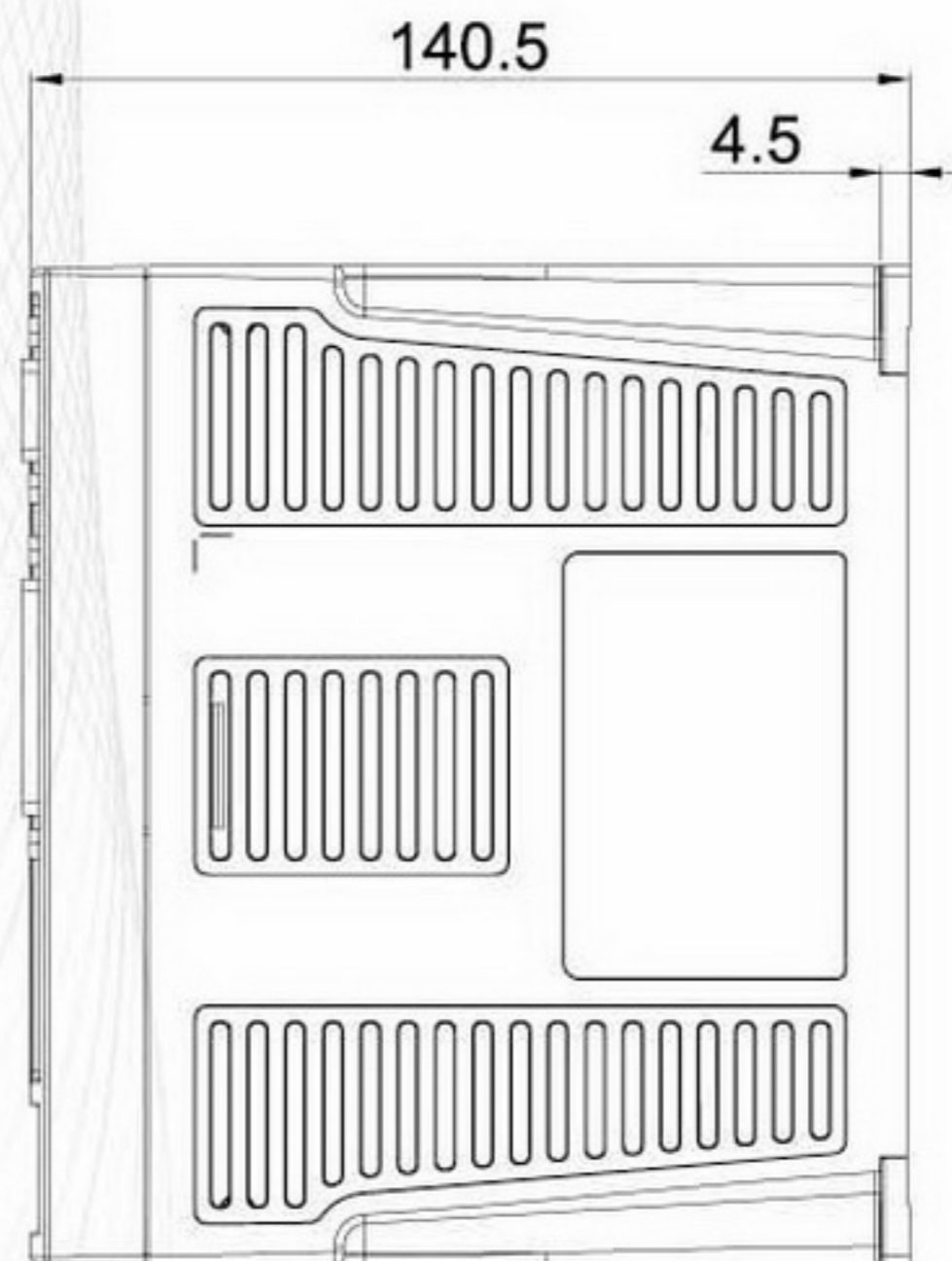
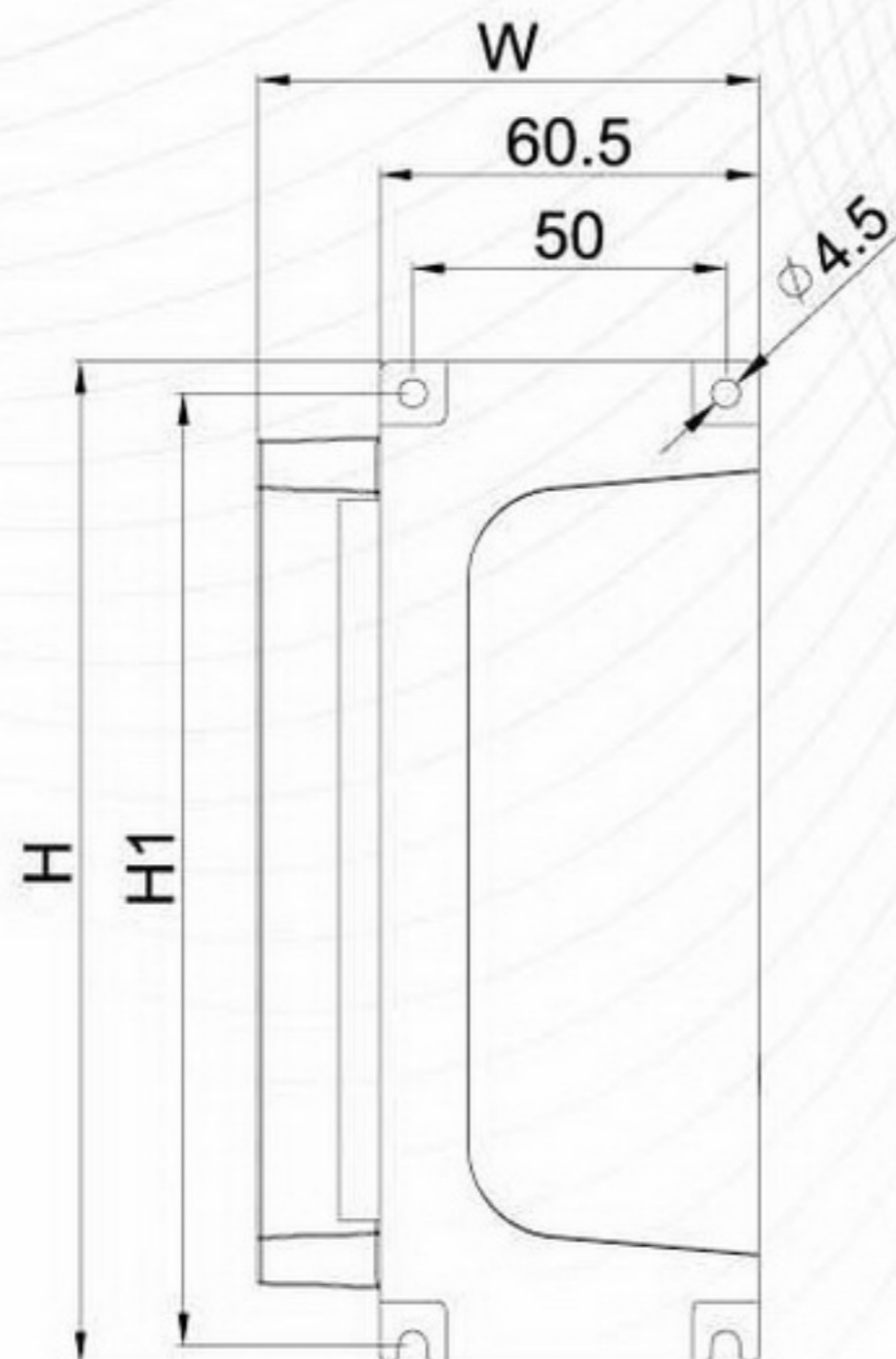



JSDE Specifications

Servo Pack Model JSDE-□□□□		10A	15A	20A	30A	50A3
Applicable Servo Motors JSMA-□□□□		SCP5	SC04*	SC04	SC08	MA15
		SC01	LC03	SC08*	MA10	MB15
		—	—	LC08	MB10	MC15
		—	—	MA05	MC10	MB20
		—	—	MH05	MH10	MC20
Basic Specifications	Max. Applicable Servo Motor Capacity [KW]	0.1	0.4	0.8	1.0	2.0
	Continuous Output Current [A rms]	0.94	3.5	4.4	5.16	9.5
	Max. Output Current [A rms]	2.82	10.5	13.2	15.5	28.5
	Input Power Supply	Single-phase / Three-phase 170 ~ 253Vac				
	Main Circuit R、S、T	50 / 60Hz ±5%				
	Cooling System	Natural Air Circulation			Fan Cooling	
	Control Method	Three-phase full-wave rectification IGBT-PWM (sine-wave driven)				
Feedback [Encoder Resolution]	Incremental Encoder : 2000ppr / 2500ppr					
Internal Functions	LED Display	Power lamps ; Five 7-segment LEDs ; Four function keys				
	Control Mode	Position (External or Internal) 、 Speed 、 Torque and Dual control mode (P/S 、 S/T 、 P/T)				
	Regenerative Discharge	Built-in braking transistor (External braking resistor connectable)				
	Protective Functions	Under voltage 、 Over voltage 、 Over load 、 Over current 、 Encoder error 、 Abnormal DI/DO programming 、 Memory abnormal 、 Emergency stop 、 Pulse deviation value 、 Over speed 、 CPU abnormal 、 Limit switch error 、 Over heat				
	Communication Interface	RS-232 / RS-485 (Modbus protocol)				
	Command Source	External pulse train / Internal parameters (16 programmable position settings)				
Position Control Mode	Input Signals	Type	Positive/Negative edge triggered : Sign + Pulse train 、 CCW + CW pulse train 、 90° phase difference 2-phase pulse (phase A + phase B)			
		Form	Line Driver (+5V level) 、 Open Collector (+5 ~ +24V level)			
		Frequency	Maximum 500 / 200 kpps (line driver/open collector)			
	Electronic Gear Ratio	1/200 ≤ A/B ≤ 200 (A=1 ~ 50000 ; B=1 ~ 50000)				
	Position Time Constant	Smoothing : 0 ~ 10sec				
	Final Position Tolerance	0 ~ 50000 Pulse				
	Feed Forward Compensation	0 ~ 100 %				
	Homing Function	Set by parameters				
Speed Control Mode	Command Source	External analog signal / Internal parameters (3 speeds set-up)				
	Analog Input Signals	Voltage Range	0 ~ ±10Vdc / 0 ~ 4500rpm (set by parameters)			
		Impedance	10KΩ			
	Speed Control Range	1 : 5000 (Internal) / 1 : 2000 (External)				
	Speed Fluctuation Rate	0.03% or less at load fluctuation 0 ~ 100% (at rated speed)				
		0.2% or less at power fluctuation ±10% (at rated speed) 0.5% or less at ambient temperature fluctuation 0 ~ 50 °C (at rated speed)				
	Accel./Decel. Time Constant	Linear : 0 ~ 50sec ; S curve : 0 ~ 5sec ; Smoothing : 0 ~ 10sec				
	Frequency Characteristics	Maximum 300Hz (at J _L =J _M)				
Torque Limit Operation	External analog signal / Internal parameters					
Zero Speed / Speed Reach Range	0 ~ 4500rpm (set by parameters)					
Torque Control Mode	Command Source	External analog signal				
	Analog Input Signals	Voltage Range	0 ~ ±10Vdc / 0 ~ ±300%			
		Impedance	10KΩ			
	Accel./Decel. Time Constant	Linear : 0 ~ 50sec				
	Speed Limit Operation	External analog signal / Internal parameters				
Torque Reach Range	0 ~ 300% (set by parameters)					
Input/Output Signals	Position Output	Form	Phase A、B、Z Line Driver / Phase Z Open Collector			
		Frequency Dividing Ratio	Rotation resolution Divided by 1 ~ 63			
	Digital Input [NPN/PNP]	6 ports Signal allocation can be modified.	Servo on 、 Alarm reset 、 P/PI switching 、 Forward/Reverse limit switch 、 External torque limit 、 Pulse deviation clear 、 Servo lock 、 Emergency stop 、 Speed command selection 、 Control mode switching 、 Pulse command inhibit 、 Gain switching 、 Electronic gear ratio setting 、 Internal pulse command trigger 、 Internal pulse command pause 、 Homing mode positioning 、 External reference signal 、 Internal position command switching 、 Speed/Torque command reverse 、 Torque mode forward/reverse start			
Digital Output [Photocoupler]	3 ports Signal allocation can be modified.	Servo ready 、 Servo alarm 、 Zero speed 、 Brake interlock 、 Speed reach 、 Positioning completed 、 Homing completed 、 Torque reach				
Environment	Installation Site	Indoor location (avoiding direct sunshine) No corrosive liquid and gas (avoiding oil mist 、 flammable gas 、 dust)				
	Altitude	Altitude 1000M or lower above sea level				
	Temperature	Operating temperature : 0 ~ 50°C ; Storage temperature : -20 ~ +85°C				
	Humidity	90%RH or less (with no condensation)				
	Vibration	10 ~ 57Hz : 20m/s ² ; 57 ~ 150Hz : 2G				

* Transient torque is 2.4 times rated torque for this combination.



Servo Motor Model Designation

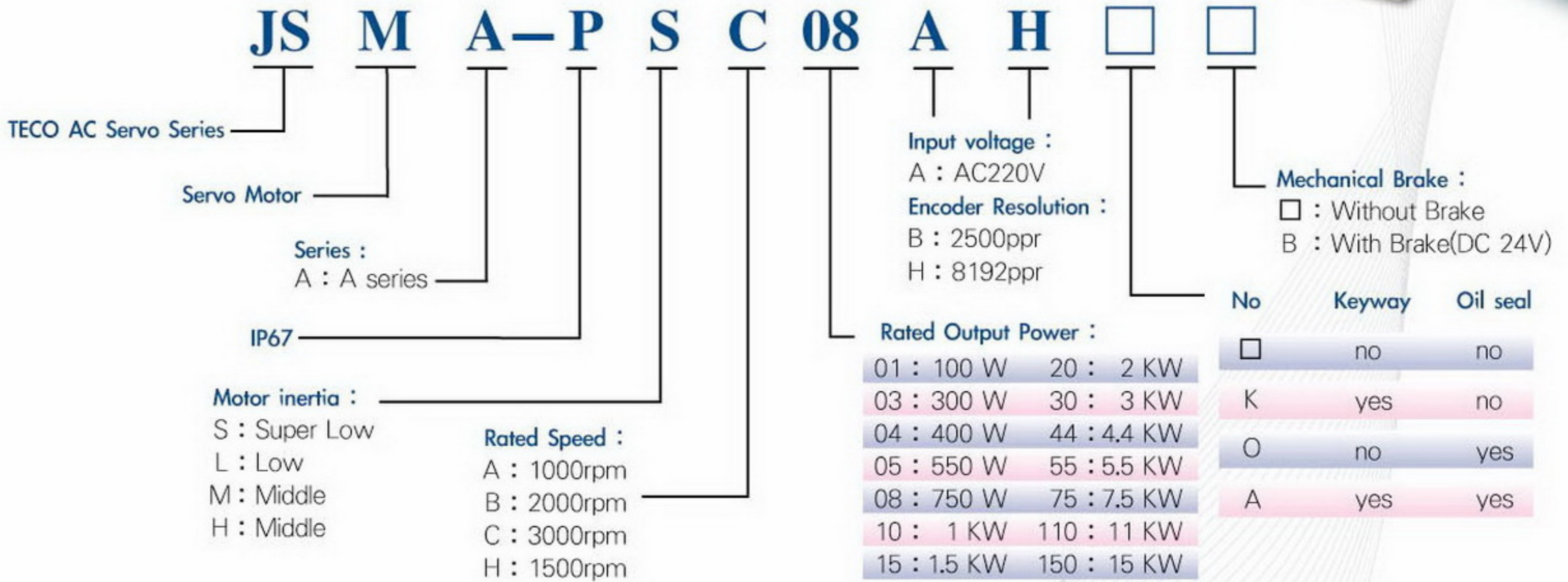

* The information above is for model description, please contact our sales for more details.



Standard Specifications

S / T / L series Low Inertia
(50W~750W)



Motor Mode	Symbol	Unit	JSMA-P □ □ □ □						
			SCP5	SC01	SC04	SC08	LC03	LC08	
Standard / Customization			Standard	Standard	Standard	Standard	Standard	Standard	
Drive Mode			10A	10A/15A	15A/20A	20A/30A	15A	20A	
Rate Output	P _R	KW	0.05	0.1	0.4	0.75	0.3	0.75	
Rated Torque	T _R	N·m	0.16	0.32	1.27	2.39	0.95	2.39	
Max. Torque	T _{max}	N·m	0.48	0.95	3.82	7.16	2.86	7.16	
Rated Speed	N _R	rpm	3000			3000			
Max. Speed	N _{max}	rpm	4500			4200			
Rated Current	I _R	A	0.65	0.94	3.5	4.3	2.0	3.4	
Max. Armature Current	I _{max}	A	1.95	2.82	10.5	12.9	6.0	10.2	
Torque Constant	K _T	N·m/A	0.356	0.380	0.39	0.610	0.523	0.774	
Induced Voltage Constant	K _E	V/k rpm	40.4	39.8	40.4	63.8	54.8	81.4	
Rotor Moment of Inertia	J _M	Kg·cm ²	0.029	0.036	0.277	0.940	0.677	2.459	
Armature Resistance	R _a	Ω	71.00	25.00	1.96	2.41	5.58	2.18	
Armature Inductance	L _a	mH	24.3	35.0	3.8	8.0	11.6	6.8	
Mechanical Time Constant	T _m	ms	1.43	0.59	0.34	0.58	1.32	0.85	
Electrical Time Constant	T _e	ms	0.34	1.40	1.94	3.30	2.08	3.12	
Weight (standard)	W	kgw	0.48	0.70	1.37	2.47	1.59	3.05	
Insulation Grade	—	—	Class B (130°C)			Class F (155°C)		Class F (155°C)	
Operating Ambient Temp.	T	°C	0 ~ 40			0 ~ 40			
Operating Ambient Humidity	RH	%	<80			<90			
Storage Temp.	T	°C	-20 ~ 60			-20 ~ 60			
Storage Humidity	RH	%	<80			<90			

1(kgf·cm)=0.0980665(N·m) ; 1(gf·cm·s)=0.980665(kg·cm)



Standard Specifications



M series Middle Inertia (550W~3KW)

Motor Mode	Symbol	Unit	JSMA-P□□□□				
			MA05	MA10	MA15	MH05	MH10
Standard / Customization			Standard	Standard	Standard	Customization	Customization
Drive Mode			20A	30A	30A/50A3	20A	30A
Rate Output	P _R	KW	0.55	1.0	1.5	0.55	1.0
Rated Torque	T _R	N·m	5.25	9.55	14.32	3.50	6.40
Max. Torque	T _{max}	N·m	15.76	28.65	42.96	10.51	19.21
Rated Speed	N _R	rpm		1000			1500
Max. Speed	N _{max}	rpm		1500			2000
Rated Current	I _R	A	3.43	5.16	7.45	2.98	5.0
Max. Armature Current	I _{max}	A	10.3	15.5	22.35	8.94	15.0
Torque Constant	K _T	N·m/A	1.679	2.039	2.110	1.293	1.411
Induced Voltage Constant	K _E	V/k rpm	175.9	213.6	221.3	135.6	147.6
Rotor Moment of Inertia	J _M	Kg·cm ²	6.26	12.14	17.92	6.26	12.14
Armature Resistance	R _a	Ω	3.58	1.85	1.19	2.31	0.95
Armature Inductance	L _a	mH	18.33	12.14	8.44	10.80	8.78
Mechanical Time Constant	T _m	ms	0.76	0.52	0.46	0.83	0.55
Electrical Time Constant	T _e	ms	5.12	6.55	7.09	4.68	9.28
Weight (standard)	W	kgw	6.45	10.18	13.87	6.45	10.18
Insulation Grade	—	—	Class B (130°C)				
Operating Ambient Temp.	T	°C	0 ~ 40				
Operating Ambient Humidity	RH	%	<90				
Storage Temp.	T	°C	-20 ~ 60				
Storage Humidity	RH	%	<90				

1(kgf·cm)=0.0980665(N·m) ; 1(gf·cm·s)=0.980665(kg·cm²)

Motor Mode	Symbol	Unit	JSMA-P□□□□							
			MB10	MB15	MB20	MB30	MC10	MC15	MC20	MC30
Standard / Customization			Standard	Standard	Standard	Standard	Customization	Customization	Customization	Customization
Drive Mode			30A	30A/50A3	50A3	75A3	30A	30A/50A3	50A3	75A3
Rate Output	P _R	KW	1.0	1.5	2.0	3.0	1.0	1.5	2.0	3.0
Rated Torque	T _R	N·m	4.78	7.16	9.55	14.33	3.20	4.78	6.37	9.55
Max. Torque	T _{max}	N·m	14.33	21.49	28.65	42.96	9.60	14.33	19.11	28.65
Rated Speed	N _R	rpm		2000				3000		
Max. Speed	N _{max}	rpm		2800				4000		
Rated Current	I _R	A	5.16	7.57	9.18	14.0	4.96	7.06	9.5	14.0
Max. Armature Current	I _{max}	A	15.5	22.71	27.5	42.0	14.88	21.2	28.5	42.0
Torque Constant	K _T	N·m/A	1.019	1.060	1.140	1.130	0.715	0.740	0.740	0.750
Induced Voltage Constant	K _E	V/k rpm	106.8	108.7	119.3	118.3	74.6	77.5	77.4	78.5
Rotor Moment of Inertia	J _M	Kg·cm ²	6.26	8.88	12.14	17.92	4.60	6.26	8.88	12.14
Armature Resistance	R _a	Ω	1.22	0.79	0.58	0.33	1.02	0.65	0.40	0.25
Armature Inductance	L _a	mH	6.70	4.74	3.78	2.12	5.06	3.58	2.40	1.62
Mechanical Time Constant	T _m	ms	0.70	0.61	0.52	0.45	0.88	0.71	0.62	0.51
Electrical Time Constant	T _e	ms	5.49	6.00	6.52	6.38	4.96	5.48	6.00	6.56
Weight (standard)	W	kgw	6.47	8.08	10.16	13.87	5.29	6.49	8.08	10.16
Insulation Grade	—	—	Class B (130°C)							
Operating Ambient Temp.	T	°C	0 ~ 40							
Operating Ambient Humidity	RH	%	<90							
Storage Temp.	T	°C	-20 ~ 60							
Storage Humidity	RH	%	<90							

1(kgf·cm)=0.0980665(N·m) ; 1(gf·cm·s)=0.980665(kg·cm²)

MH / HH series Middle Inertia (3KW~15KW)



Motor Mode	Symbol	Unit	JSMA-P□□□□				
			MH30	MH44	MH55	MH75	MH110
Standard / Customization			Standard	Standard	Standard	Standard	Standard
Drive Mode			75A3	100A3	150A3	200A3	300A3
Rate Output	P _R	KW	3.0	4.4	5.5	7.5	11.0
Rated Torque	T _R	N·m	19.1	28.0	35.1	47.8	70.1
Max. Torque	T _{max}	N·m	49.5	71.5	89.6	122.6	179.0
Rated Speed	N _R	rpm	1500				
Max. Speed	N _{max}	rpm	2000				
Rated Current	I _R	A	15.0	22.5	28.5	38.0	58.0
Max. Armature Current	I _{max}	A	39.0	58.5	74.1	98.8	152.0
Torque Constant	K _T	N·m/A	1.27	1.24	1.23	1.26	1.21
Induced Voltage Constant	K _E	V/k rpm	81.32	82.23	81.20	81.62	83.40
Rotor Moment of Inertia	J _M	Kg·cm ²	39.99	51.44	63.52	93.94	160.94
Armature Resistance	R _a	Ω	0.18	0.12	0.09	0.05	0.03
Armature Inductance	L _a	mH	2.89	1.98	1.52	1.02	0.80
Mechanical Time Constant	T _m	ms	0.69	0.60	0.56	0.49	0.48
Electrical Time Constant	T _e	ms	16.12	16.81	17.24	18.96	26.77
Weight (standard)	W	kgw	19.5	26.2	30.0	42.0	52.5
Insulation Grade	—	—	Class F (155°C)				
Operating Ambient Temp.	T	°C	0 ~ 40				
Operating Ambient Humidity	RH	%	<90				
Storage Temp.	T	°C	-20 ~ 60				
Storage Humidity	RH	%	<90				

1(kgf·cm)=0.0980665(N·m) ; 1(kgf·cm·s)=0.980665(kg·cm²)

Motor Mode	Symbol	Unit	JSMA-P□□□□				
			MH150	HH30	HH44	HH55	HH75
Standard / Customization			Standard	Standard	Standard	Standard	Standard
Drive Mode			300A3	100A3	150A3	200A3	300A3
Rate Output	P _R	KW	15.0	3.0	4.4	5.5	7.5
Rated Torque	T _R	N·m	95.5	19.1	28.0	35.1	47.8
Max. Torque	T _{max}	N·m	204.0	49.5	71.4	89.6	122.6
Rated Speed	N _R	rpm	1500	1500			
Max. Speed	N _{max}	rpm	2000	3000			
Rated Current	I _R	A	78.0	23.0	33.2	42.1	58.0
Max. Armature Current	I _{max}	A	170.0	59.8	86.3	109.5	151.0
Torque Constant	K _T	N·m/A	1.22	0.83	0.84	0.83	0.82
Induced Voltage Constant	K _E	V/k rpm	83.10	54.21	54.82	53.27	53.75
Rotor Moment of Inertia	J _M	Kg·cm ²	222.20	39.99	53.02	63.52	93.94
Armature Resistance	R _a	Ω	0.02	0.08	0.05	0.04	0.02
Armature Inductance	L _a	mH	0.50	1.48	0.89	0.68	0.43
Mechanical Time Constant	T _m	ms	0.37	0.70	0.62	0.56	0.51
Electrical Time Constant	T _e	ms	29.12	18.75	16.54	17.46	18.00
Weight (standard)	W	kgw	70.5	19.5	26.2	30.0	42.0
Insulation Grade	—	—	Class F (155°C)				
Operating Ambient Temp.	T	°C	0 ~ 40				
Operating Ambient Humidity	RH	%	<90				
Storage Temp.	T	°C	-20 ~ 60				
Storage Humidity	RH	%	<90				

1(kgf·cm)=0.0980665(N·m) ; 1(kgf·cm·s)=0.980665(kg·cm²)



Servo Motor Dimension

Servo Motor Mode		A	B	C	D	E	F	G	H	I	J	K	L	M	
JSMA-PL Series	Without Brake	LC03AB/H	φ 5.5	φ 100	φ 90	76	2	5	φ 14	φ 70	25	20	3	30	113.4
		LC08AB/H	φ 6.5	φ 112	φ 100	86	2	5	φ 16	φ 80	30	25	3	35	148
		LC08AB/H-0C	φ 6.5	φ 112	φ 100	86	2	5	φ 19	φ 80	30	25	3	35	148
	With Brake	LC03AB/H	φ 5.5	φ 100	φ 90	76	2	5	φ 14	φ 70	25	20	3	30	147.8
		LC08AB/H	φ 6.5	φ 112	φ 100	86	2	5	φ 16	φ 80	30	25	3	35	183.2
		LC08AB/H-0C	φ 6.5	φ 112	φ 100	86	2	5	φ 19	φ 80	30	25	3	35	183.2
JSMA-PS Series	Without Brake	SCP5AB/H	φ 3.5	φ 55	φ 48	42	-	-	φ 8	φ 30	22.5	16	2.5	25	85.8
		SC01AB/H	φ 3.5	φ 55	φ 48	42	-	-	φ 8	φ 30	22.5	16	2.5	25	106.8
		SC04AB/H	φ 5.5	-	φ 70	60	2	5	φ 14	φ 50	25	20	3	30	121.7
		SC08AB/H	φ 5.5	-	φ 90	80	2.5	6	φ 19	φ 70	35	30	3	40	139
	With Brake	SC04AB/H	φ 5.5	-	φ 70	60	2	5	φ 14	φ 50	25	20	3	30	157.1
		SC08AB/H	φ 5.5	-	φ 90	80	2.5	6	φ 19	φ 70	35	30	3	40	174

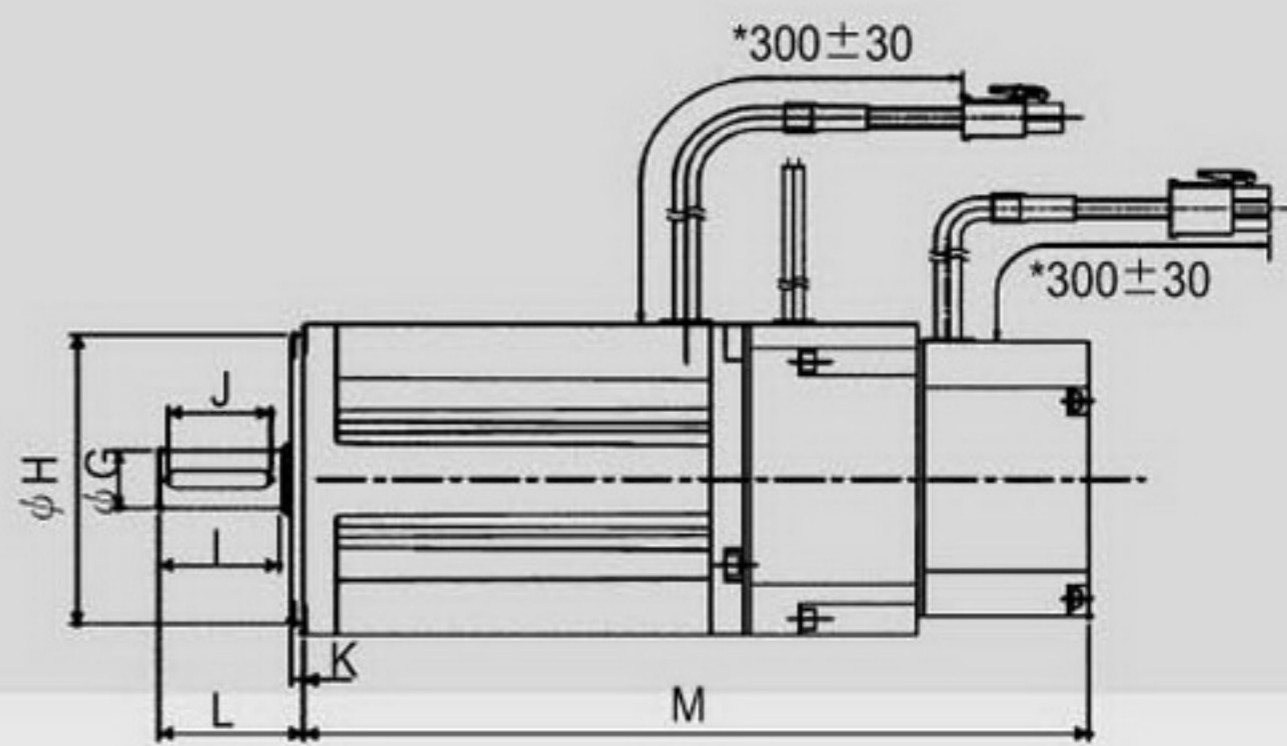
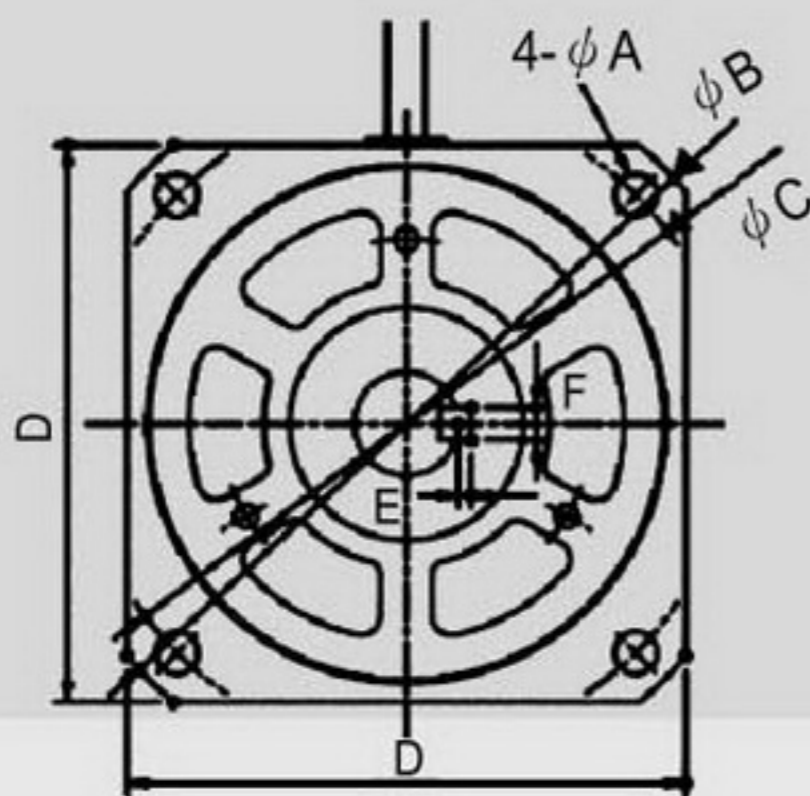

Servo Motor Mode		LZ	LA	LC	U	W	S	LB	LE	Q	LL	L	
JSMA-PM JSMA-PH Series	Without Brake	MA05	9	145	130	2.5	6	22	110	6	58	164.8	222.8
		MH05	9	145	130	2.5	6	22	110	6	58	164.8	222.8
		MA10	9	145	130	2.5	6	22	110	6	58	214.8	272.8
		MB10	9	145	130	2.5	6	22	110	6	58	164.8	222.8
		MC10	9	145	130	2.5	6	22	110	6	58	149.8	207.8
		MH10	9	145	130	2.5	6	22	110	6	58	214.8	272.8
		MA15	9	145	130	2.5	6	22	110	6	58	264.8	322.8
		MB15	9	145	130	2.5	6	22	110	6	58	184.8	242.8
		MC15	9	145	130	2.5	6	22	110	6	58	164.8	222.8
		MB20	9	145	130	2.5	6	22	110	6	58	214.8	272.8
		MC20	9	145	130	2.5	6	22	110	6	58	184.8	242.8
		MB30	9	145	130	2.5	6	22	110	6	58	264.8	322.8
		MC30	9	145	130	2.5	6	22	110	6	58	214.8	272.8
		MH30	13.5	200	180	5	10	35	114.3	3.2	79	245	324
		MH44	13.5	200	180	5	10	35	114.3	3.2	79	273.5	352.5
	MH55	13.5	200	180	5	12	42	114.3	3.2	113	282.8	395.5	
	MH75	13.5	200	180	5	12	42	114.3	3.2	113	371	484	
	MH110	13.5	235	220	5	12	42	200	4	116	343.5	459.5	
	MH150	13.5	235	220	5	12	42	200	4	116	418.5	534.5	
	HH30	13.5	200	180	5	10	35	114.3	3.2	79	245	324	
	HH44	13.5	200	180	5	10	35	114.3	3.2	79	273.5	252.5	
	HH55	13.5	200	180	5	12	42	114.3	3.2	113	282.5	395.5	
	HH75	13.5	200	180	5	12	42	114.3	3.2	113	371	484	
	With Brake	MA05	9	145	130	2.5	6	22	110	6	58	219.8	277.8
		MH05	9	145	130	2.5	6	22	110	6	58	219.8	277.8
		MA10	9	145	130	2.5	6	22	110	6	58	269.8	327.8
		MB10	9	145	130	2.5	6	22	110	6	58	219.8	277.8
		MC10	9	145	130	2.5	6	22	110	6	58	204.8	262.8
		MH10	9	145	130	2.5	6	22	110	6	58	269.8	327.8
		MA15	9	145	130	2.5	6	22	110	6	58	319.8	377.8
MB15		9	145	130	2.5	6	22	110	6	58	239.8	297.8	
MC15		9	145	130	2.5	6	22	110	6	58	219.8	277.8	
MB20		9	145	130	2.5	6	22	110	6	58	269.8	327.8	
MC20		9	145	130	2.5	6	22	110	6	58	239.8	297.8	
MB30		9	145	130	2.5	6	22	110	6	58	319.8	377.8	
MC30		9	145	130	2.5	6	22	110	6	58	269.8	327.8	

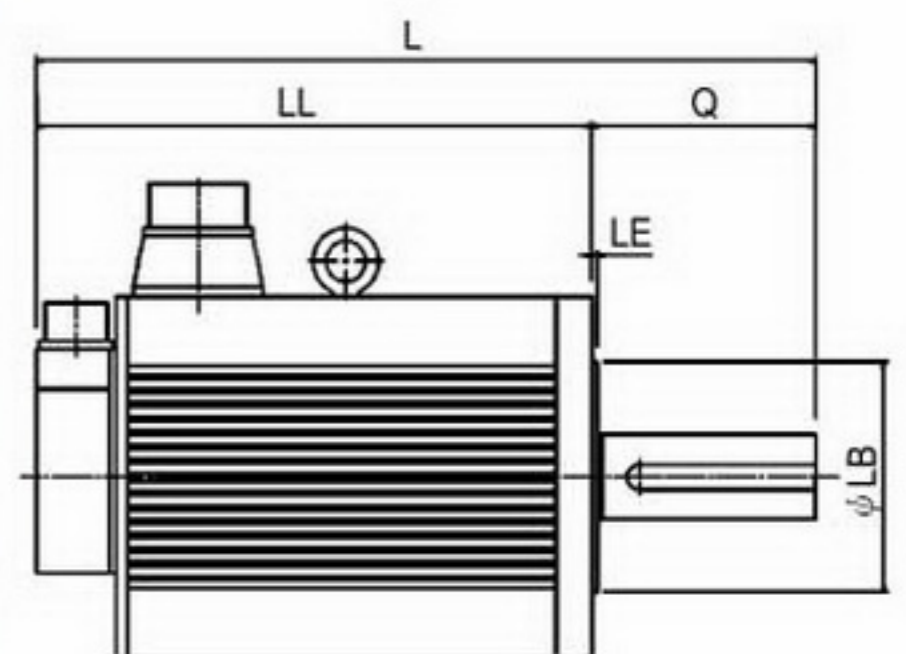
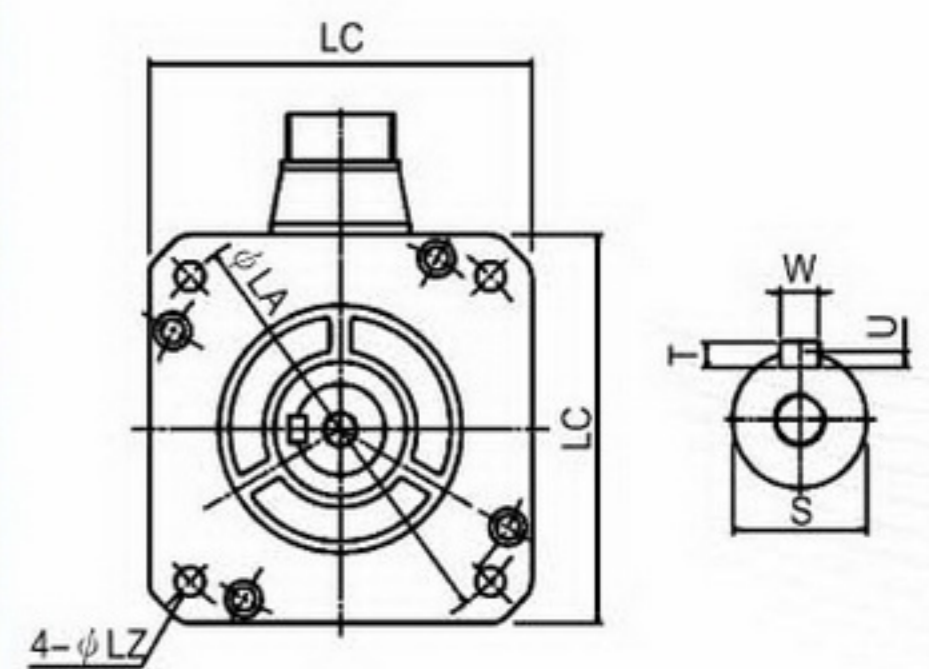





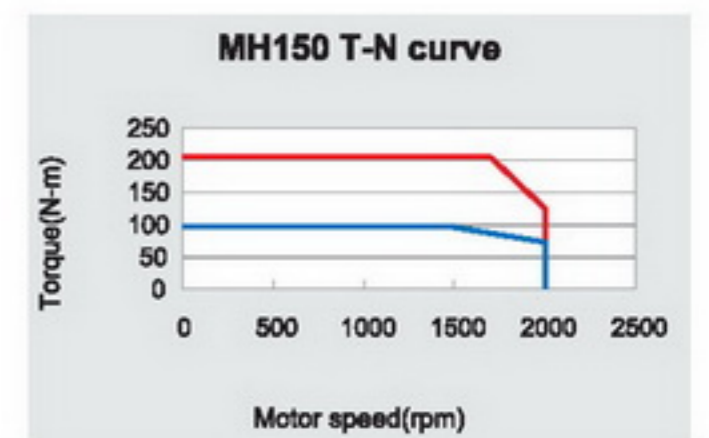
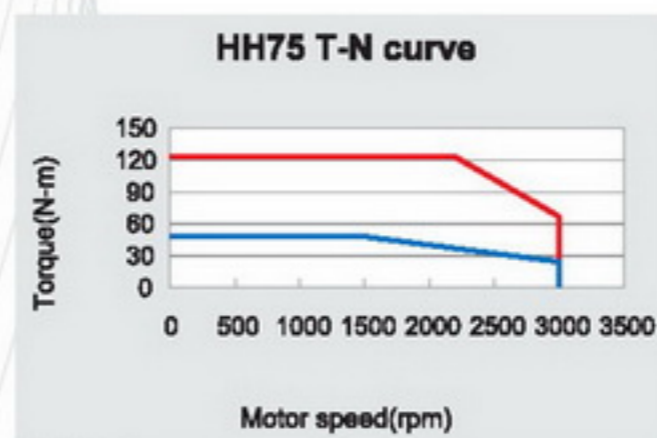
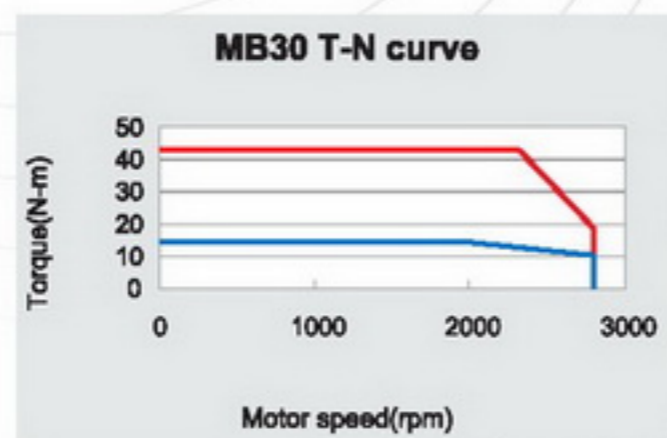
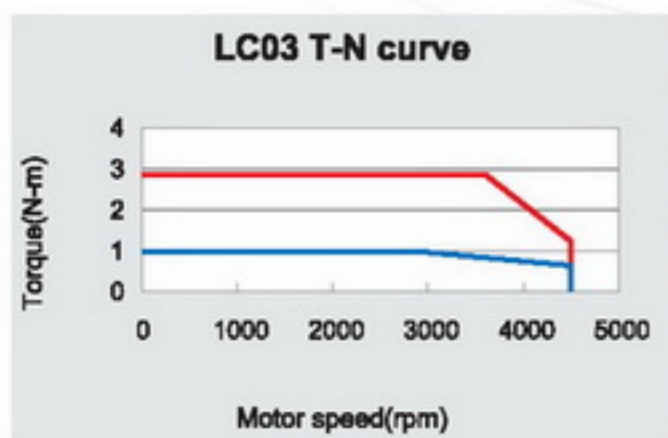
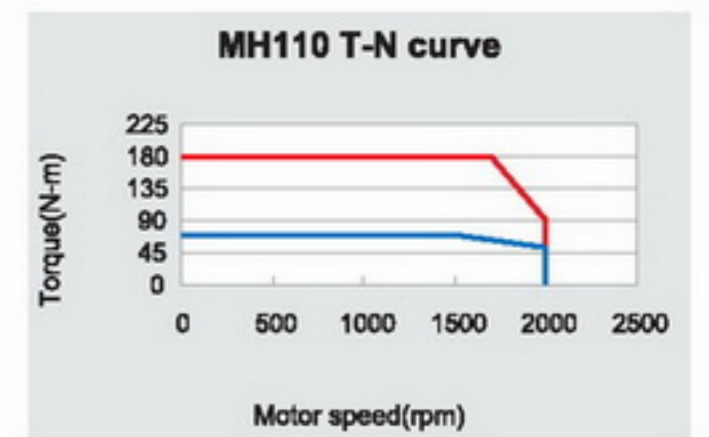
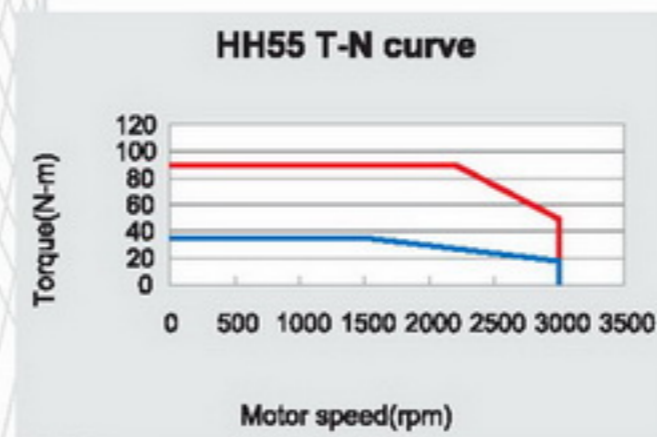
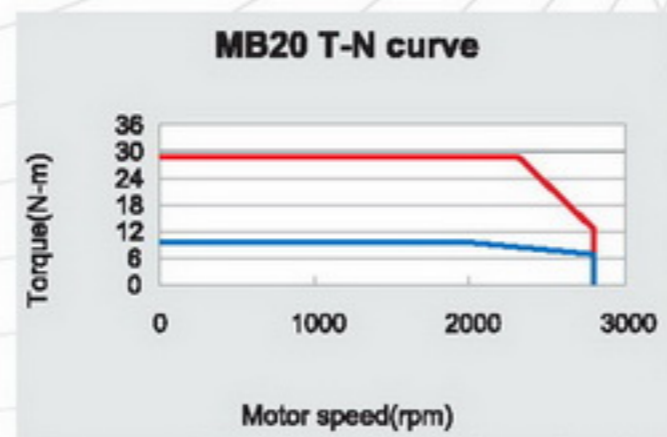
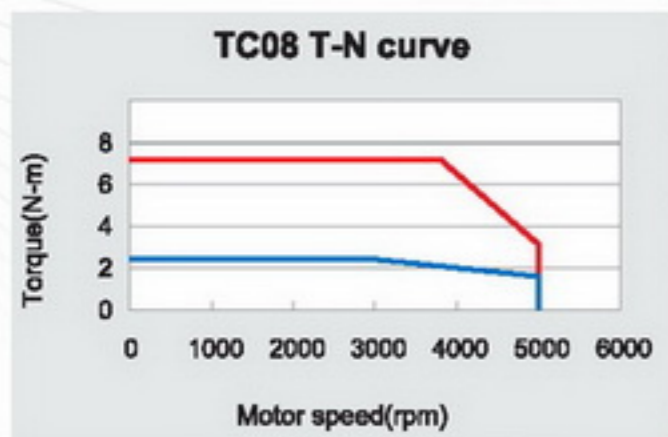
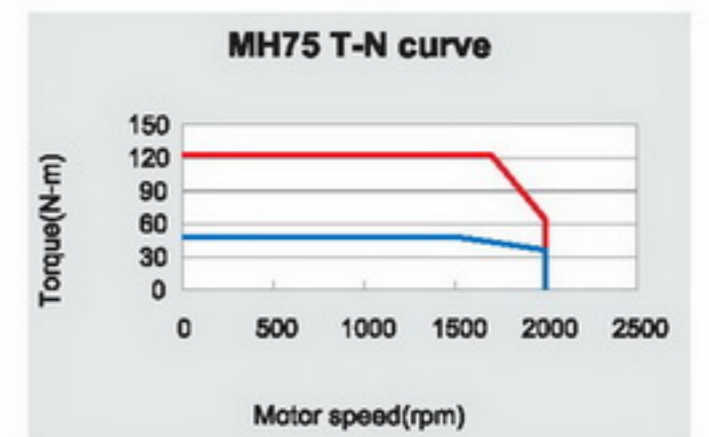
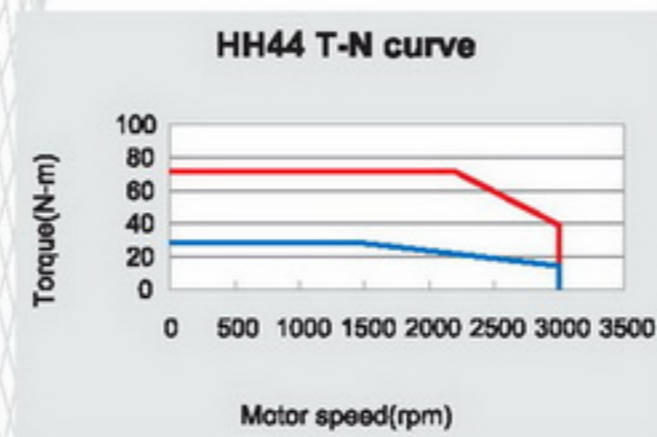
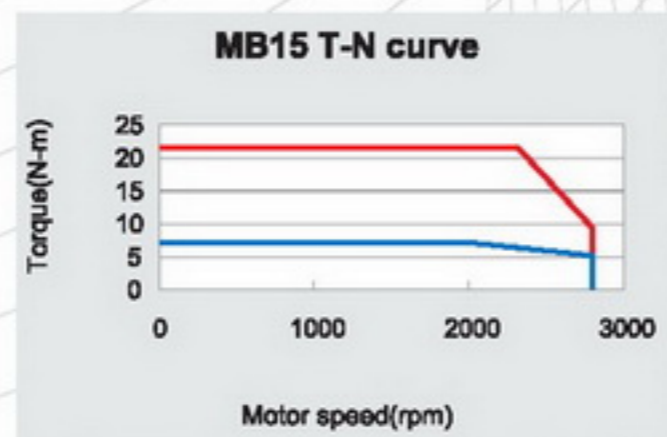
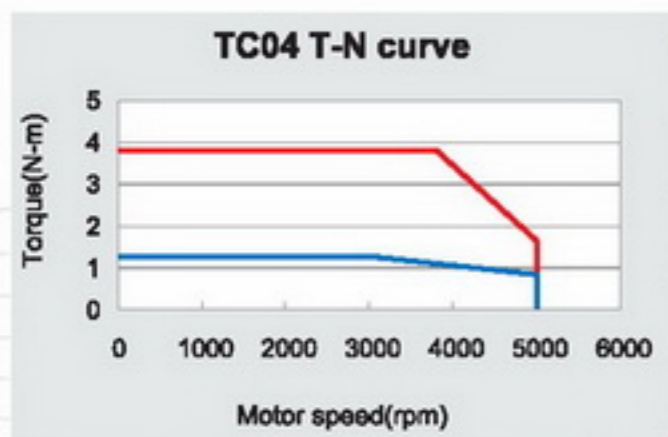
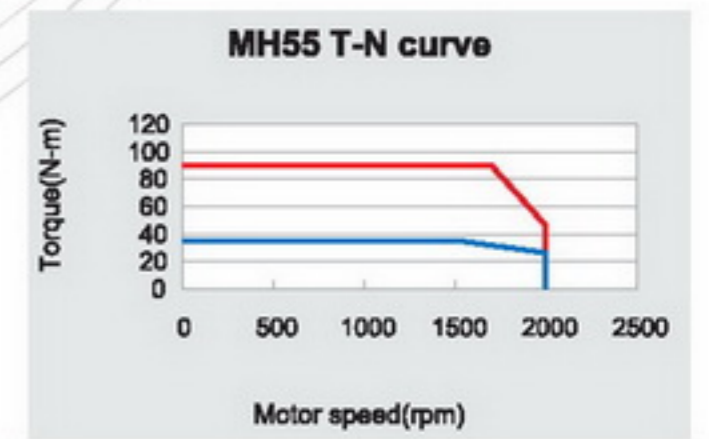
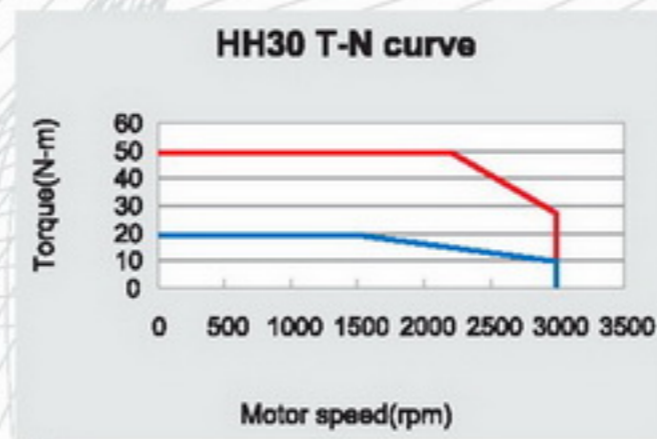
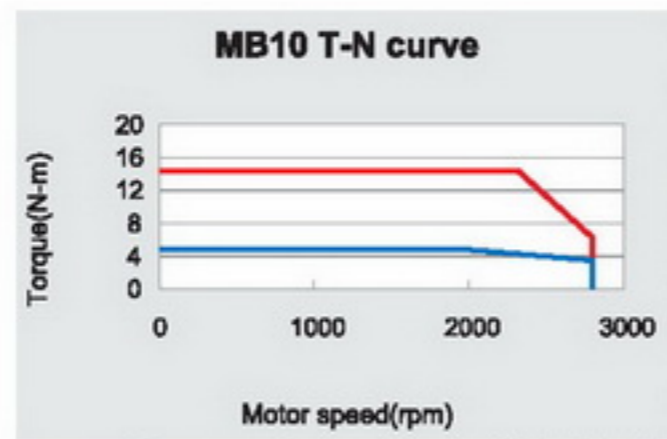
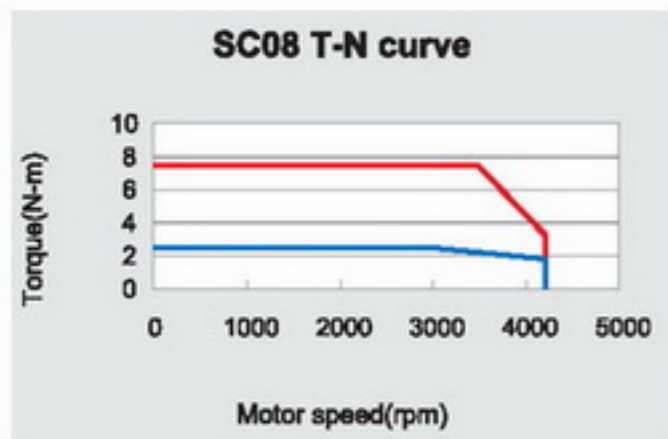
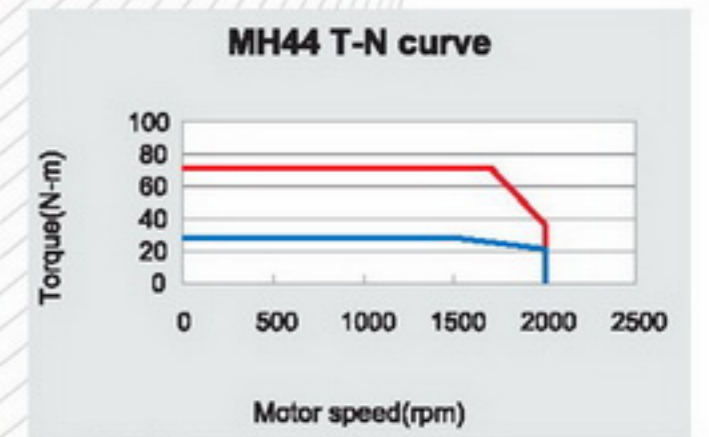
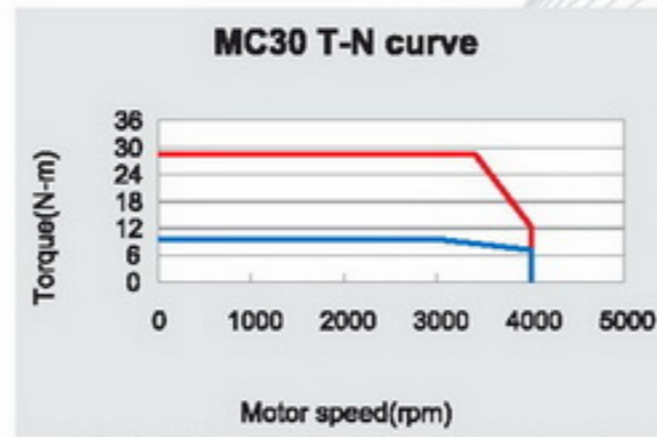
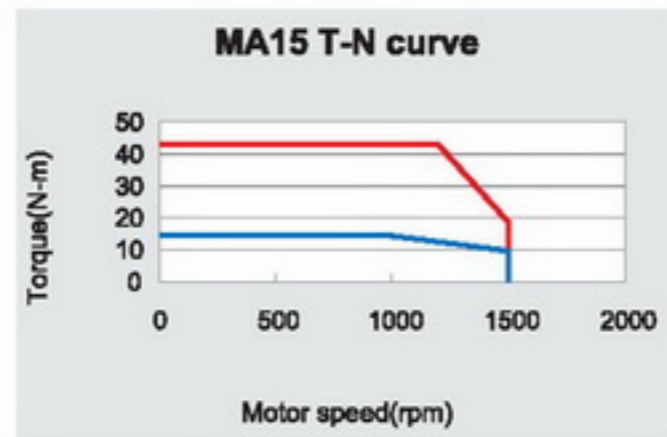
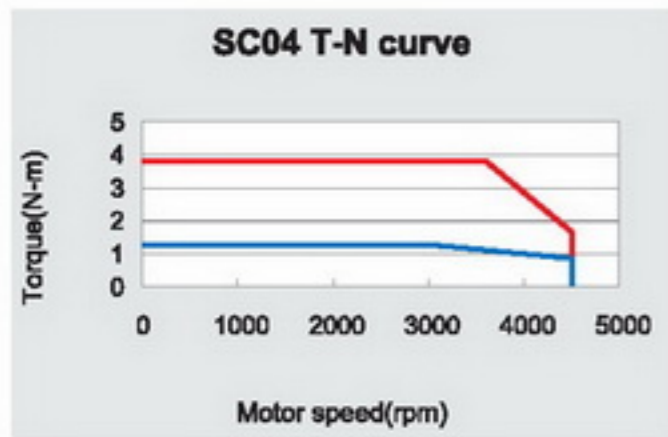
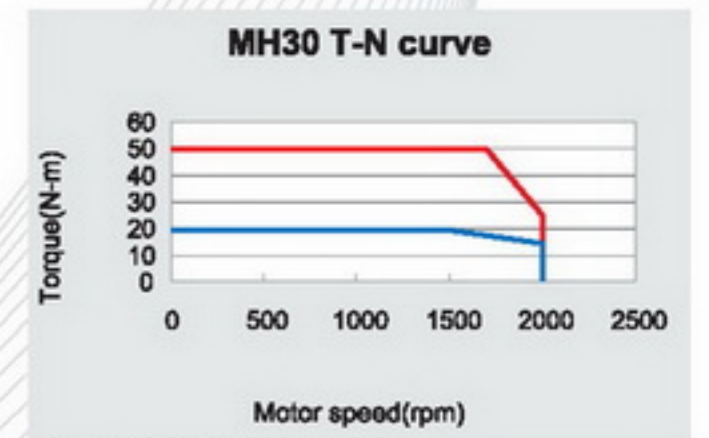
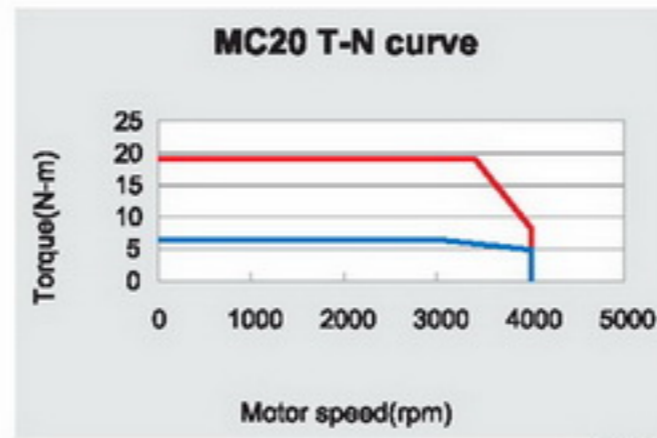
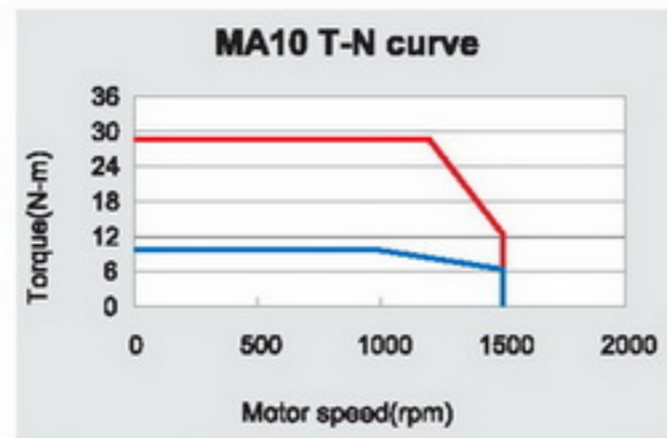
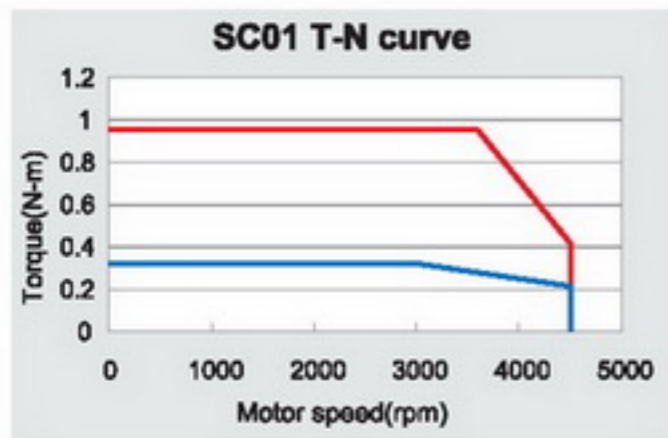
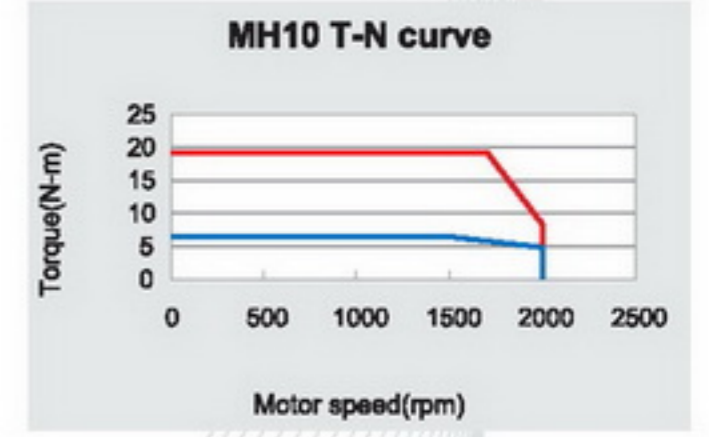
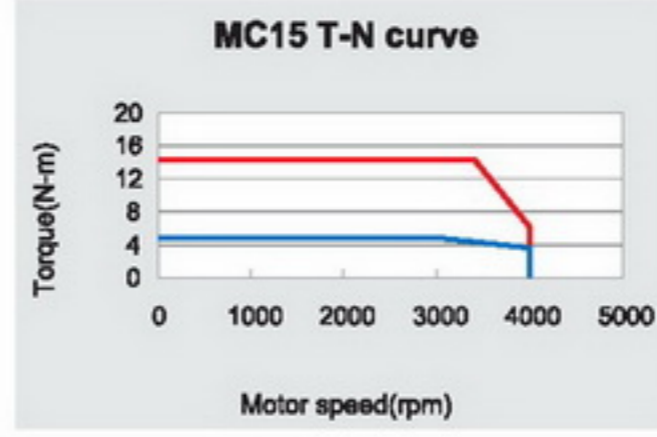
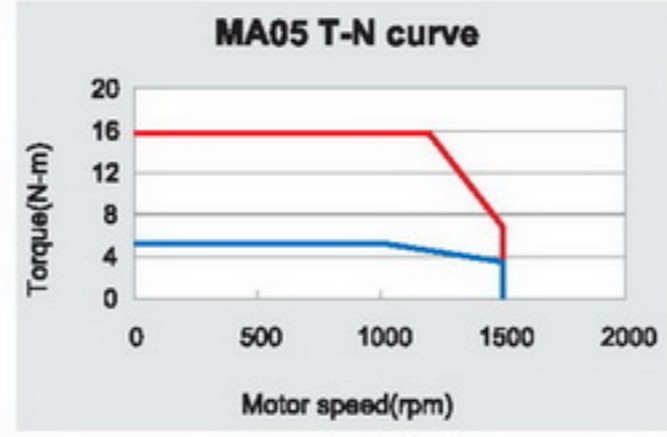
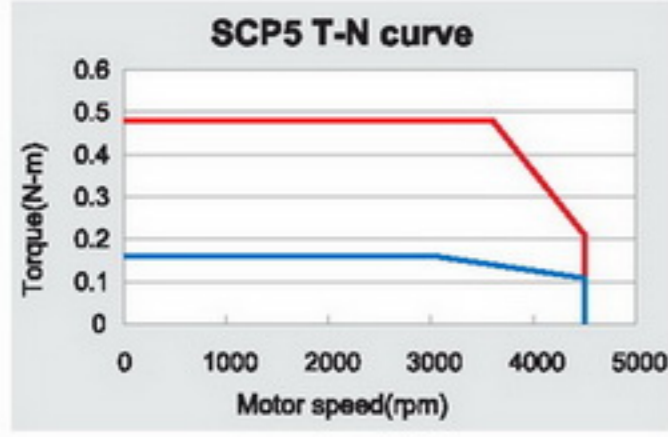
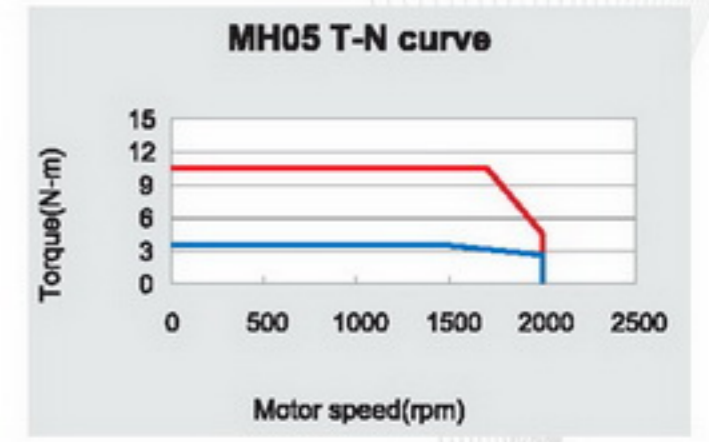
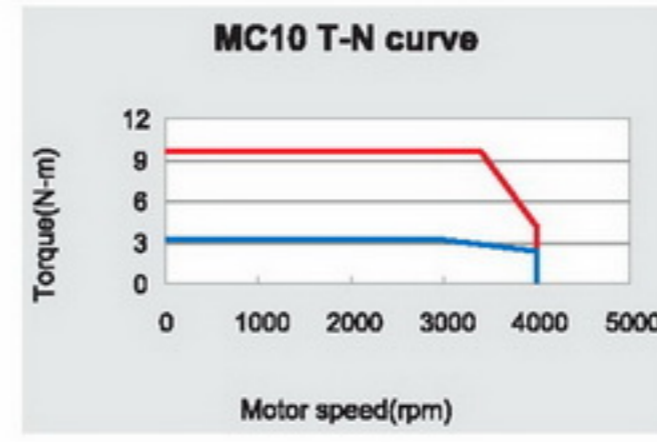
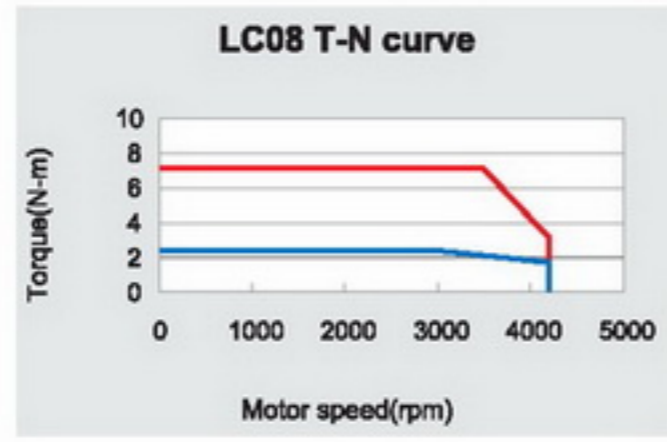

PERFORMANCE CURVE

— Intermittent
— Continuous

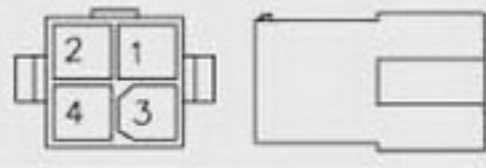
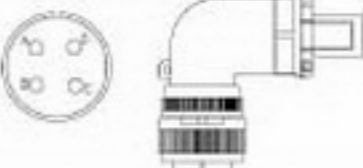



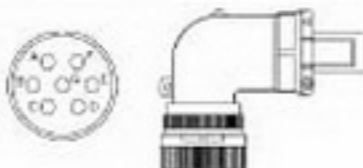
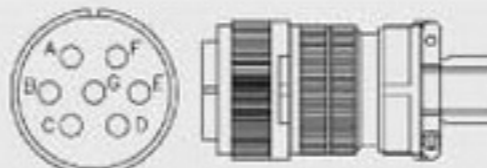

Power Connectors

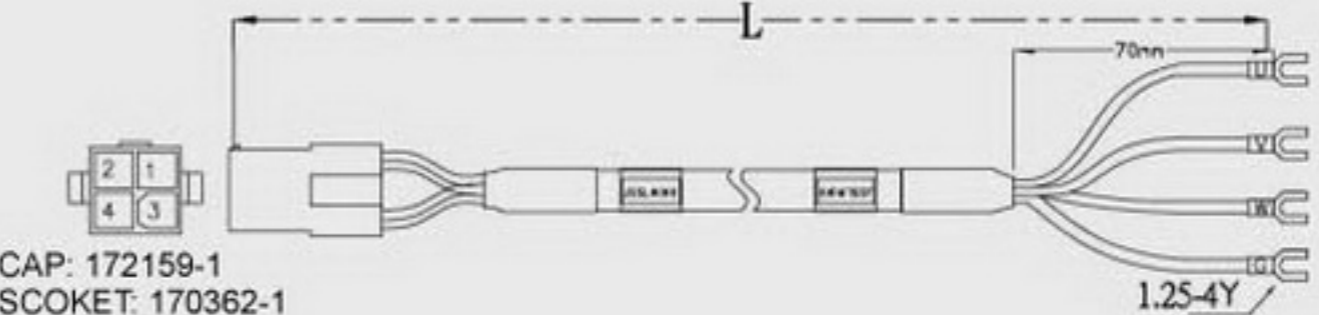
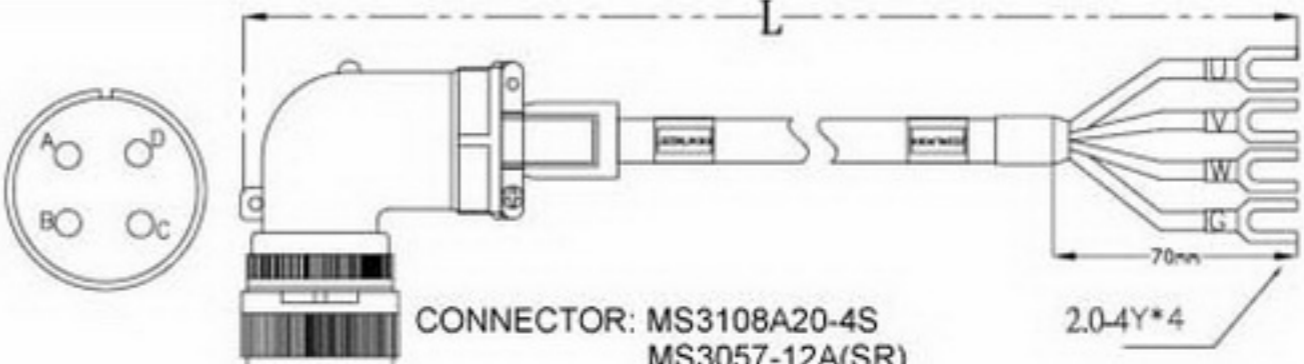
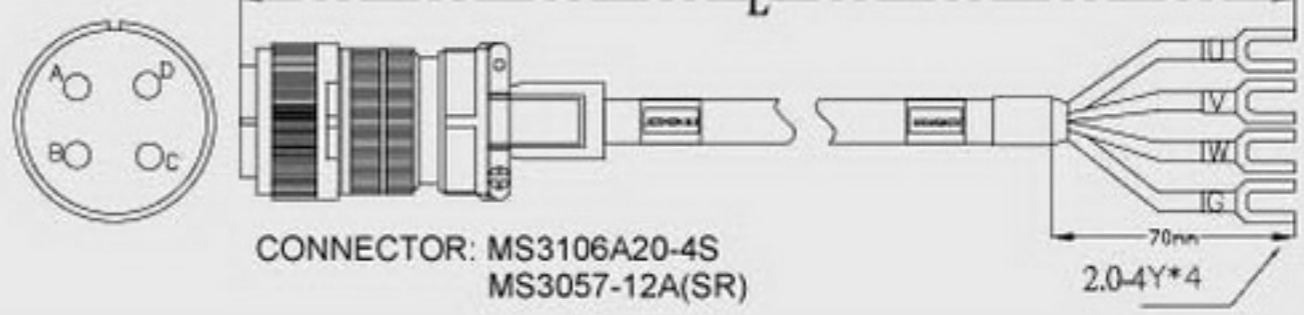
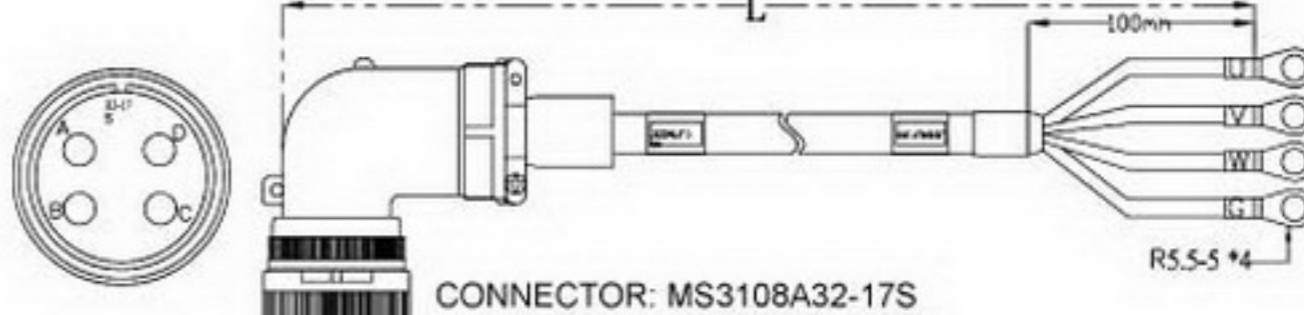
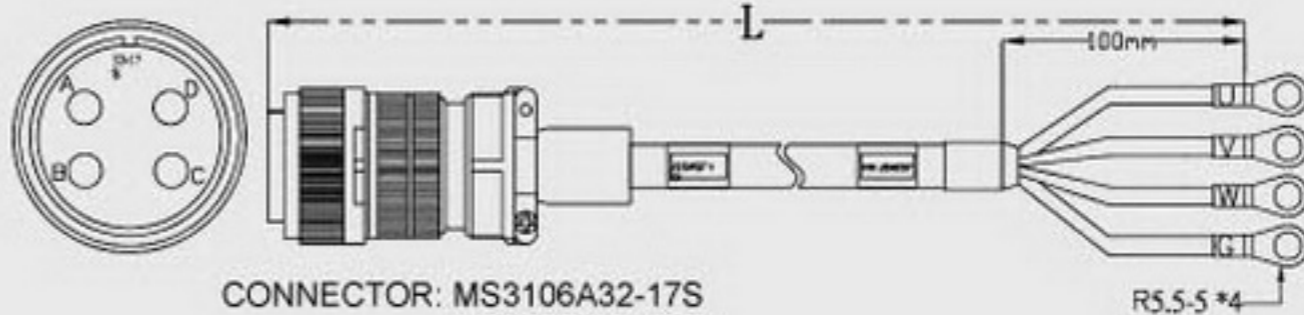
Part No.	Description	Model.
JSSCNM04	For JSMA - S / L / T series (50W~750W)	 CAP: 172159-1 SCOKET: 170362-1
JSSCNML04	For JSMA - M series Without Brake (550W~3KW)	 CONNECTOR: MS3108A20-4S MS3057-12A(SR)
JSSCNMS04	For JSMA - M series Without Brake (550W~3KW)	 CONNECTOR: MS3106A20-4S MS3057-12A(SR)
JSSCNBL04	For JSMA - ^{MH} / _{HH} series Without Brake (3KW~15KW)	 CONNECTOR: MS3108A32-17S MS3057-20A(SR)
JSSCNBS04	For JSMA - ^{MH} / _{HH} series Without Brake (3KW~15KW)	 CONNECTOR: MS3106A32-17S MS3057-20A(SR)
JSSCNML07	For JSMA - M series With Brake (550W~3KW)	 CONNECTOR: MS3108A20-15S MS3057-12A(SR)
JSSCNMS07	For JSMA - M series With Brake (550W~3KW)	 CONNECTOR: MS3106A20-15S MS3057-12A(SR)

Power Cables

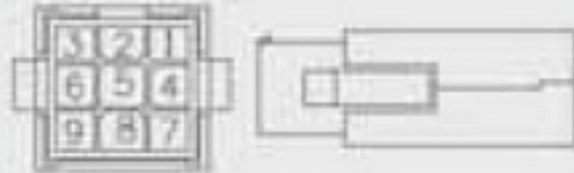
Part No.	L (Meter)	Description	Model.
JSSLM001	1	For JSMA - S / L / T series (50W~750W)	 CAP: 172159-1 SCOKET: 170362-1 1.25-4Y
JSSLM003	3		
JSSLM005	5		
JSSLM010	10		
JSSLM015	15		
JSSLM020	20		
JSSMLM001	1	For JSMA - M series Without Brake (550W~3KW)	 CONNECTOR: MS3108A20-4S MS3057-12A(SR) 2.0-4Y*4
JSSMLM003	3		
JSSMLM005	5		
JSSMLM010	10		
JSSMLM015	15		
JSSMLM020	20		
JSSMSM001	1	For JSMA - M series Without Brake (550W~3KW)	 CONNECTOR: MS3106A20-4S MS3057-12A(SR) 2.0-4Y*4
JSSMSM003	3		
JSSMSM005	5		
JSSMSM010	10		
JSSMSM015	15		
JSSMSM020	20		
JSSBLM001	1	For JSMA - ^{MH} / _{HH} series Without Brake (3KW~5.5KW)	 CONNECTOR: MS3108A32-17S MS3057-20A(SR) R5.5-5 *4
JSSBLM003	3		
JSSBLM005	5		
JSSBLM010	10		
JSSBLM015	15		
JSSBLM020	20		
JSSBSM001	1	For JSMA - ^{MH} / _{HH} series Without Brake (3KW~5.5KW)	 CONNECTOR: MS3106A32-17S MS3057-20A(SR) R5.5-5 *4
JSSBSM003	3		
JSSBSM005	5		
JSSBSM010	10		
JSSBSM015	15		
JSSBSM020	20		

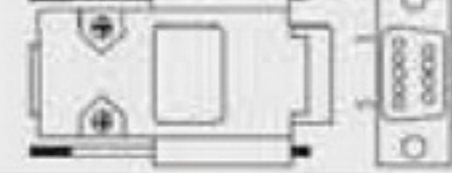

Encoder Connectors

Part No.	Description	Model.
JSSCNP09	For JSMA - S / L / T series	 CONNECTOR: 172161-1 TERMINAL: 170361-1
JSSCNPL09	For JSMA - M series	 CONNECTOR: MS3108A20-18S MS3057-12A(SR)
JSSCNPS09	For JSMA - M series	 CONNECTOR: MS3106A20-18S MS3057-12A(SR)
JSSCN20P	For JSDA series (CN2)	 CONNECTOR: 10320-52A0-008 12120-3000PE
JSSECN09P	For JSDE series (CN2)	 CONNECTOR: D-SUB9PM male COVER: DC-9CT screw

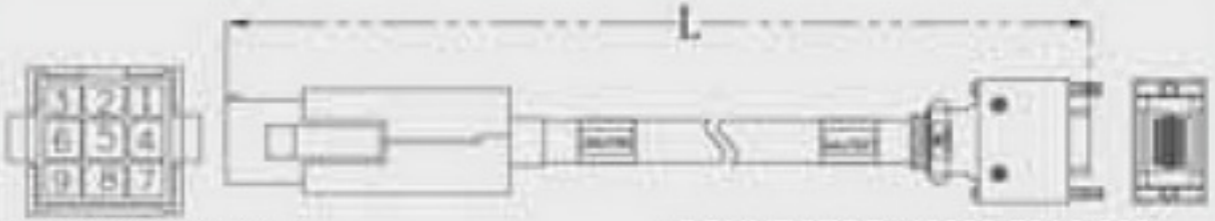
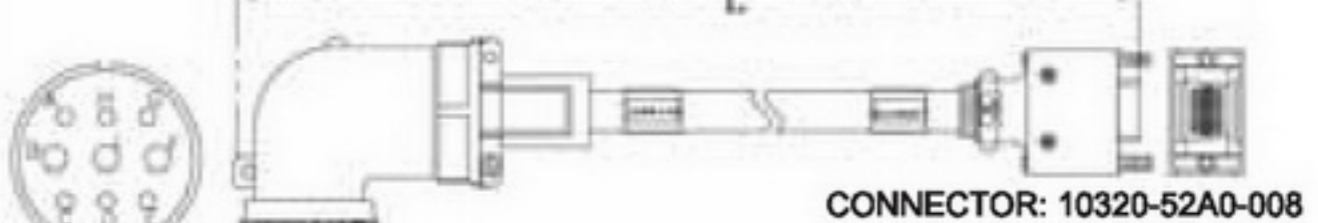
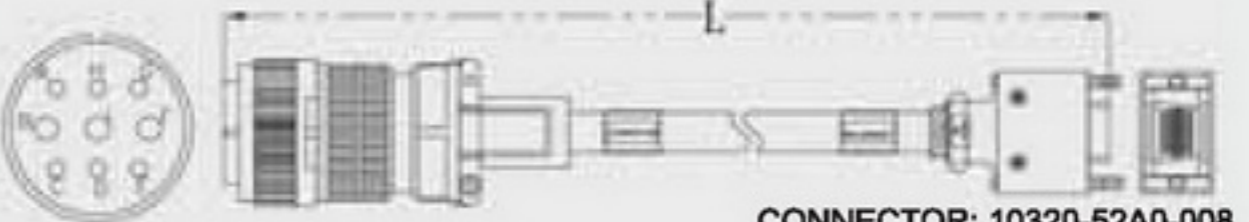
Encoder Cables (For JSDA series)

Part No.	L (Meter)	Description	Model.
JSSLP001	1	For JSMA - S / L / T series and JSDA Combinations	 CONNECTOR: 172161-1 TERMINAL: 170361-1 CONNECTOR: 10320-52A0-008 10120-3000PE
JSSLP003	3		
JSSLP005	5		
JSSLP010	10		
JSSLP015	15		
JSSLP020	20		
JSSMLP001	1	For JSMA - M series and JSDA Combinations	 CONNECTOR: MS3108A20-18S MS3057-12A(SR) CONNECTOR: 10320-52A0-008 10120-3000PE
JSSMLP003	3		
JSSMLP005	5		
JSSMLP010	10		
JSSMLP015	15		
JSSMLP020	20		
JSSMSP001	1	For JSMA - M series and JSDA Combinations	 CONNECTOR: MS3108A20-18S MS3057-12A(SR) CONNECTOR: 10320-52A0-008 10120-3000PE
JSSMSP003	3		
JSSMSP005	5		
JSSMSP010	10		
JSSMSP015	15		
JSSMSP020	20		

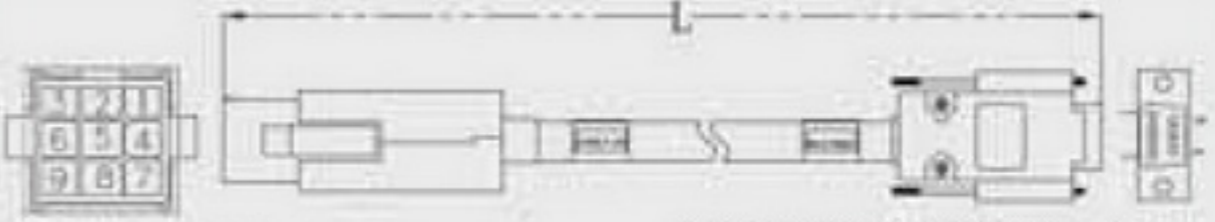
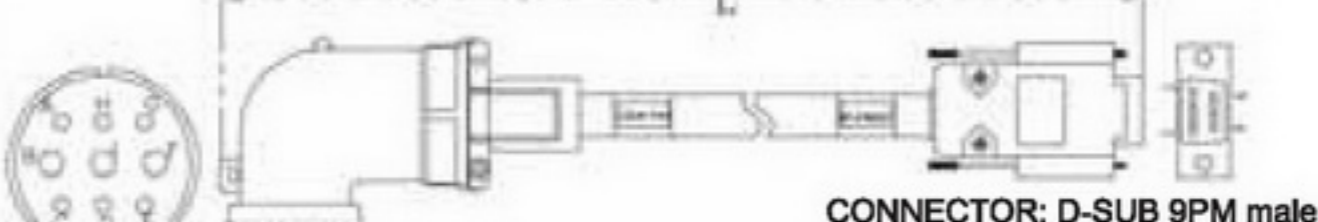
Encoder Cables (For JSDE series)

Part No.	L (Meter)	Description	Model.
JSSELP001	1	For JSMA - S / L / T series and JSDE Combinations	 CONNECTOR: 172161-1 TERMINAL: 170361-1 CONNECTOR: D-SUB 9P male COVER: DC-9CT screw
JSSELP003	3		
JSSELP005	5		
JSSELP010	10		
JSSELP015	15		
JSSELP020	20		
JSSEMLP001	1	For JSMA - M series and JSDE Combinations	 CONNECTOR: MS3108A20-18S MS3057-12A(SR) CONNECTOR: D-SUB 9PM male COVER: DC-9CT screw
JSSEMLP003	3		
JSSEMLP005	5		
JSSEMLP010	10		
JSSEMLP015	15		
JSSEMLP020	20		
JSSEMSP001	1	For JSMA - M series and JSDE Combinations	 CONNECTOR: MS3106A20-18S MS3057-12A(SR) CONNECTOR: D-SUB 9P male COVER: DC-9CT screw
JSSEMSP003	3		
JSSEMSP005	5		
JSSEMSP010	10		
JSSEMSP015	15		
JSSEMSP020	20		

Peripheral

I/O Signal Connector

Part No.	Description	Model.
JSSCN50P	For JSDA series (CN1)	CONNECTOR: 10350-52A0-008 10150-3000PE
JSSECN25P	For JSDE series (CN1)	CONNECTOR: D-SUB 25P M male COVER: DC-25 CT screw

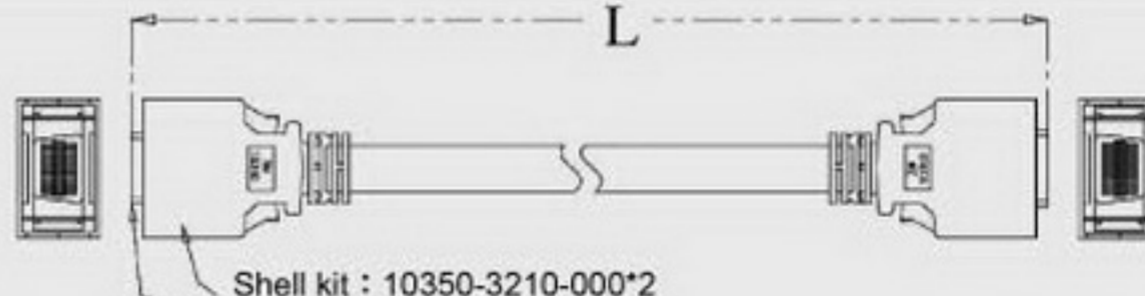
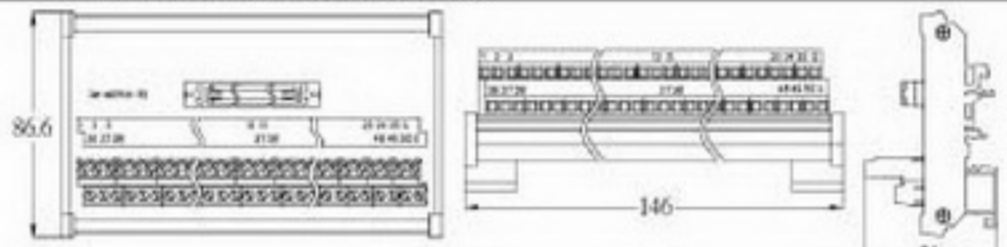

Terminal Block (For JSDA series)

Part No.	L (Meter)	Description	Model.
JSSTBC0P5	0.5	For JSDA series (CN1) Connection Cable	 <p>Shell kit : 10350-3210-000*2 SCSI II : 10150-6000PE*2</p>
JSSTBC001	1		
JSSTBC002	2		
JSSTB50P	—	For JSDA series (CN1) Terminal Block	

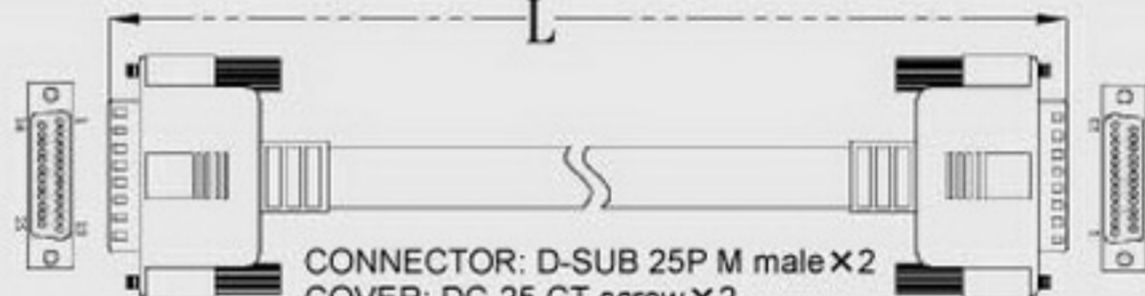
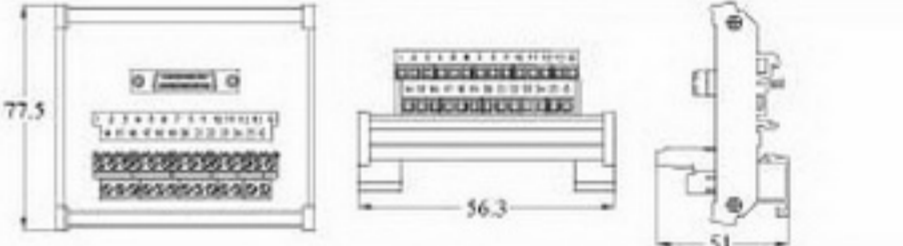
Terminal Block (For JSDE series)

Part No.	L (Meter)	Description	Model.
JSSETBC0P5	0.5	For JSDE series (CN1) Connection Cable	 <p>CONNECTOR: D-SUB 25P M male X 2 COVER: DC-25 CT screw X 2</p>
JSSETBC001	1		
JSSETBC002	2		
JSSETB25P	—	For JSDE series (CN1) Terminal Block	

Communication Cables

Part No.	L (Meter)	Description	Model.
JSSDTC001	1	For connection to PC	 <p>D-9S MD-8P</p>
JSSDTC002	2		
JSSDTD001	1	For connection to Drive	 <p>MD-8P MD-8P</p>
JSSDTD002	2		

Distributor



TECO ELECTRIC & MACHINERY CO., LTD.

10F, No.3-1, Yuan Cyu St., Nan-Kang District, Taipei City 115, Taiwan
TEL:+886-2-6615-9111Ext.1724 FAX:+886-2-6615-1033 <http://www.teco.com.tw>

GJ-35-05 2010-08-16